

GULGAN NORTH, BRUNSWICK HEADS

REVISION I
20TH APRIL 2023

TRAFFIC
IMPACT STUDY

INGEN
CONSULTING
ENGINEERED WITH PURPOSE

DOCUMENT CONTROL

Revision number	Description	Prepared	Reviewed	Issued	Issue date
A	Client review	JN	MK	MK	3/12/21
B	Planning Proposal	JN	MK	MK	22/12/21
C	Council RFI	MK	MK	MK	7/2/22
D	TfNSW RFI	MK	MK	MK	16/6/22
E	Council RFI	MK	MK	MK	27/9/22
F	Council RFI	MK	MK	MK	22/11/22
G	Council RFI	MK	MK	MK	13/1/23
H	Council RFI	MK	MK	MK	2/2/23
I	Council instruction	MK	MK	MK	20/4/23

Document title: Traffic Impact Study for Gulgan North, Brunswick Heads

Document number: J1143_TIS

Author: Michiel Kamphorst, *MSc, BSc, RPEng, RPEQ, NER, MAAS*

Client name: Gulgan Road Property Pty Ltd

Client's representative: Steve Connelly (Planners North)

Approved for use by:

Name: Michiel Kamphorst

Signature:



Date: 20th April 2023

MSc, BSc, RPEng, RPEQ, NER, MAAS

Ingen Consulting information

Ingen Consulting Pty Ltd, ABN 18 623 948 112

Alstonville NSW 2477

+61 4 1726 4987

michiel@ingenconsulting.com.au

www.ingenconsulting.com.au

© Ingen Consulting Pty Ltd. Copyright in the whole and every part of the document belongs to Ingen Consulting Pty Ltd and may not be used, sold, transferred, copied, or reproduced in whole or in part in any manner or form in or on any media to any person other than by agreement with Ingen Consulting Pty Ltd. This document is produced by Ingen Consulting Pty Ltd solely for the benefit and use by the client in accordance with the terms of engagement. Ingen Consulting Pty Ltd cannot accept any responsibility for any use of or reliance on the contents of this report by any third party.

CONTENTS

Document control	2
Contents	3
Table of figures.....	5
Table of tables.....	7
1. Introduction	8
1.1. Scope	8
1.2. Standards, policies, and guidelines	9
1.3. Notes on this revision	10
1.4. Record of consultation with TfNSW.....	11
1.5. Site description	11
1.6. Proposed development.....	13
2. Existing conditions	15
2.1. Subject site	15
2.2. Gulgan Road traffic surveys	16
2.3. Intersection surveys.....	18
2.4. Gulgan Road	20
2.5. Existing crash statistics	21
3. Proposed development.....	23
3.1. Development description	23
3.2. Proposed intersections	24
3.3. Main access road	24
3.4. Trip generation for Traditional Industrial area	25
3.5. Trip generation for Business Park	31
3.6. Development trip generation	35
3.7. The Saddle Road	36
4. Traffic impact parameters.....	37
4.1. Design horizon.....	37
4.2. Traffic scenarios	37

4.3.	Historic trends.....	37
4.4.	Covid-19 pandemic impacts on transport modelling	39
4.5.	Byron Shire Residential Strategy.....	42
4.6.	Trip distribution	46
5.	Option A – Left in / left out only	49
5.1.	Intersection layout	49
5.2.	Trip distribution	49
5.3.	Intersection performance	49
5.4.	Impact on vegetation	51
6.	Option B – Roundabout.....	52
6.1.	Intersection layout	52
6.2.	Trip distribution	52
6.3.	Intersection performance	52
6.4.	Impact on vegetation	54
7.	Option C – Signalised intersection	55
7.1.	Intersection layout	55
7.2.	Trip distribution	55
7.3.	Intersection performance	55
7.4.	Impact on vegetation	58
8.	Option D – Channelised intersection.....	59
8.1.	Intersection layout	59
8.2.	Trip distribution.....	59
8.3.	Intersection performance.....	59
8.4.	Impact on vegetation	61
9.	Intersection Options analysis.....	62
10.	Sensitivity analyses	64
10.1.	Fluctuations in the background traffic growth.....	64
10.2.	Hundredth Highest Hour Volume.....	64
11.	Other modes of transport	69

11.1. Buses.....	69
11.2. Bicycle	69
11.3. Pedestrians.....	70
12. Parking	74
12.1. Business park car parking demand	74
12.2. Traditional industrial car parking demand	76
13. Conclusions and recommendations.....	77
References	78
Appendix A – Intersection survey reports	80
Appendix B – SIDRA input volumes	84
Appendix C – SIDRA output tables.....	85
Appendix D – Sensitivity analysis graphs	86
Appendix E – Record of consultation with TfNSW.....	94
Appendix F – RMS letter to BSC 7 August 2019.....	95
Appendix G – SIDRA output Option A	96
Appendix H – SIDRA output Option B	116
Appendix I – SIDRA output Option C.....	131
Appendix J – SIDRA output Option D	134

TABLE OF FIGURES

Figure 1 Site location, <i>Source of the map: Byron Shire Council Online Maps</i>	12
Figure 2 Development precinct, <i>Source aerial image: Byron Shire Council Online Maps</i>	12
Figure 3 BILS Area 5, <i>Source: Byron Shire Council</i>	13
Figure 4 Existing site gate.....	15
Figure 5 Traffic counter location, source Google Maps	17
Figure 6 Intersection’s survey locations	19
Figure 7 Western Brunswick Interchange Roundabout survey location, <i>Source: BSC online maps</i> ...	20
Figure 8 Gulgan Rd & Mullumbimby Rd & Tandy's In intersections, <i>Source: BSC online maps</i>	20
Figure 9 Cashes data on Gulgan Road since 2015, <i>Source: Transport for NSW</i>	22
Figure 10 BILS Area 5, <i>Source: Byron Shire Council</i>	23

Figure 11 Traffic survey area, IN2 zone in Alstonville, source Google Earth Pro	25
Figure 12 Russellton Industrial Estate in Alstonville, <i>Source: Ballina Intramaps 2021</i>	27
Figure 13 Manns Road survey, <i>Aerial image by Byron Shire Council online mapping</i>	29
Figure 14 Traffic survey area, B4 zone in Byron Bay, <i>Source Google Earth Pro</i>	32
Figure 15 Traffic survey area in Byron Bay, source Byron Shire Council Online Map.....	33
Figure 16 Habitat developed area, <i>Source: Byron Shire online mapping 2021</i>	34
Figure 17 Mullumbimby Road growth trends	39
Figure 18 Median 3-bed house price Mullumbimby, <i>Source: www.domain.com.au</i>	40
Figure 19 Median 4-bed house price Mullumbimby, <i>Source: www.domain.com.au</i>	41
Figure 20 Median 3-bed house price Byron Bay, <i>Source: www.domain.com.au</i>	41
Figure 21 Median 4-bed house price Byron Bay, <i>Source: www.domain.com.au</i>	41
Figure 22 Byron Shire historical population numbers, <i>Source: www.profile.id.com.au</i>	44
Figure 23 Shire-wide population growth.....	45
Figure 24 Mullumbimby historical population numbers, <i>Source: www.profile.id.com.au</i>	45
Figure 25 Travel distribution outside the analysis envelope	48
Figure 26 Option A concept layout.....	49
Figure 27 Access Road intersection Option A	50
Figure 28 Option B concept layout.....	52
Figure 29 Option B SIDRA layout	53
Figure 30 Option C concept layout	55
Figure 31 Signal phasing	56
Figure 32 Option C SIDRA layout.....	57
Figure 33 Option D intersection layout.....	59
Figure 34 Option D SIDRA layout.....	60
Figure 35 Ballina SCATS stations, <i>Source: TfNSW</i>	65
Figure 36 Weekly SCATS counts, <i>Source: TfNSW</i>	66
Figure 37 Seasonal factor	67
Figure 38 Byron Shire Council Bike Plan.....	69
Figure 39 Brunswick Roundabout pedestrian traffic AM peak	70
Figure 40 Brunswick Roundabout pedestrian traffic PM peak	71
Figure 41 Tandy’s Lane intersection pedestrian traffic AM peak	71
Figure 42 Tandy’s Lane intersection pedestrian traffic PM peak.....	72
Figure 43 Mullumbimby Road intersection pedestrian traffic AM peak.....	72
Figure 44 Mullumbimby Road intersection pedestrian traffic PM peak.....	73
Figure 45 Peak parking demand survey May 2021	74
Figure 46 Car parking survey histogram May 2021	75

TABLE OF TABLES

Table 1 GTTGD scope item warrant list	8
Table 2 Revision register	10
Table 3 Record of TfNSW consultation.....	11
Table 4 Gulgan Road traffic survey data (2019).....	16
Table 5 Gulgan Road traffic survey data (2021).....	17
Table 6 Gulgan Road traffic survey data (2022).....	18
Table 7 Russellton Industrial Estate survey results	28
Table 8 Manns Road survey results	30
Table 9 Habitat traffic survey data summary	34
Table 10 Byron STP & Byron Bay Herb Nursery data.....	35
Table 11 Habitat calculated trip generation rates	35
Table 12 Development trip generation	36
Table 13 Mullumbimby Road AADT values	38
Table 14 Trend line parameters	38
Table 15 Byron Residential Strategy trip generation	43
Table 16 Gravity model.....	46
Table 17 Development trip distribution volumes	47
Table 18 Option A Level of Service summary	50
Table 19 Option B Level of Service summary	54
Table 20 Option C Level of Service summary	57
Table 21 Option D Level of Service summary	61
Table 22 Intersection options comparison.....	62
Table 23 HHHV calculations	66
Table 24 Car parking calculations.....	76

1. INTRODUCTION

Ingen Consulting P/L has been engaged by Gulgan Road Property Pty Ltd to prepare a Traffic Impact Study (TIS) for the proposed rezoning of Area 5 as identified in the Byron Shire Business and Industrial Lands Strategy dated October 2020.

1.1. Scope

The purpose of this report is to assess the traffic impact aspects of the rezoning application in relation to the surrounding road network, in particular with respect to traffic generation, network capacity and road safety. This report seeks to:

- Demonstrate compliance with the requirements of chapter B4 of the 2014 Byron Shire Development Control Plan;
- Address relevant items recommended for a Traffic Impact Study in the 2002 Guide to Traffic Generating Developments (RTA);
- Assist with quantifying the contribution of generated traffic to the traffic volume on Gulgan Road; and
- Assist with the assessment of safety and capacity of the adjacent road network.

This report has been prepared in accordance with the requirements for a Traffic Impact Study as defined in section 2 of the Guide to Traffic Generating Developments from RTA. A detailed clarification and warrants regarding scope items included and not included are provided in Table 1 below.

Table 1 | GTTGD scope item warrant list

GTTGD scope item	Section reference in TIS if included	Warrant
Existing proposals for improvements to the adjacent road network and hierarchy	Section 4.6	-
Impact on road safety	Section 2.5	
Impact on traffic noise	-	Percentage increase in traffic not considered to warrant traffic noise study.
AADT – Annual Average Daily Traffic	-	Accurate AADT values are not available for impacted roads, only short-term ‘ADT’ type values, which

		are addressed in chapters 2 and 4.
Examine volumes and historical trends on key adjacent roads	Chapter 2 and section 4.3	
Peak period traffic volumes and congestion levels at key adjacent intersections	Chapters 4 and 10	-
Existing parking supply and demand in the vicinity of the proposed development	Chapter 12	-
Parking provisions appropriate to the development (in relation to demand and statutory requirements)	Chapter 12	-
Traffic generation / attraction and trip distribution of the proposed development	Section 4.6	-
Safety and efficiency of internal road layout, including service and parking areas	Section 3.2 and 3.3	-
Impact of generated traffic on key adjacent intersections, streets in the neighbourhood of the development, the environment and other major traffic generating development sites in close proximity	Chapter 4	-
Safety and efficiency of access between the site and the adjacent road network	Chapter 4	-

1.2. Standards, policies, and guidelines

This TIS has been prepared considering the following standards, guidelines, and policies:

- Chapter B4 of the 2014 Byron Shire DCP

- Guide to Traffic Generating Developments (RTA, 2002)
- Guide to Traffic Generating Developments, Updated Surveys (RMS 2013)
- Guide to Traffic Modelling Guidelines (RMS, 2013)
- Austroads Guide to Traffic Management
- Austroads Guide to Road Design
- Australian/New Zealand Standard 2890 series
- New South Wales Development Design Specification D1 – Geometric Road Design (Urban and Rural)

1.3. Notes on this revision

This revision is prepared in response to a recent meeting between the proponent and Council’s planners. During this meeting it was agreed that there will be no access to The Saddle Road and that the vegetation along The Saddle Road must be preserved. This agreement is consistent with our earlier advice and early published versions of this Traffic Impact Study.

As a result, we have been instructed to investigate four options for site access via Gulgan Road. These are:

- Option A – Left in / left out only. This would be subject to the construction of a roundabout at Uncle Tom’s, which is funded to the design stage by Byron Shire Council with potential construction funding by the Northern Rivers Reconstruction Corporation.
- Option B – Roundabout. Analyse the most efficient roundabout configuration studied to date (which is a single lane roundabout with southbound traffic bypass and separate left and right turning lanes from site) in order to minimise the potential for queuing back to the Brunswick Heads overpass.
- Option C – Signalised intersection. This option requires minimal disturbance of land.
- Option D – Channelised turn. This option has been designed specifically to avoid any tree removal with the Biodiversity Values Mapping layer, whilst staying clear from the Rous water mains.

The following sections have been revised compared to Revision H:

Table 2 | Revision register

Paragraph	Changes
1.6	Figure 4 deleted, and section rewritten to reflect the latest instructions.
3.2	Revised to reflect the four proposed access options.

3.7	A few comments are added regarding The Saddle Road.
4.1	Updated to reflect options study requirements
4.6	Revised.
Chapter 4	Section 4.7 and following sections deleted, will be reproduced in later chapters. Create four separate chapters (5-8) – one for each option study
Chapter 9	Summary overview of the options analysis has been added
Appendix G-J	Reconfigured these to reflect the results of each option.

1.4. Record of consultation with TfNSW

An overview of our consultation with TfNSW for this project is provided in the table below. Copies of emails are attached in Appendix E.

Table 3 | Record of TfNSW consultation

Date	Type	Topic
27 th July 2021	e-mail	Contact TfNSW for comments on proposed roundabout, speed zone changes and any relevant plans or strategies for the Pacific Motorway in the area
13 th August 2021	e-mail	Follow up on e-mail 27 th July 2021
16 th August 2021	e-mail	TfNSW response to e-mail 27 th July 2021
10 th September 2021	e-mail	Further response to e-mail
15 th November 2021	Video-conference	TfNSW traffic data
17 th November 2021	e-mail	TfNSW traffic data
18 th November 2021	e-mail	TfNSW traffic data

1.5. Site description

The site address is 66 The Saddle Road in Brunswick Heads, NSW. It is formally identified as Lot 2 DP 1159910, and its location is depicted in Figure 1. This 52-hectare parcel is located between Mullumbimby and Brunswick Heads and is intersected by The Saddle Road, Gulgan Road, and the Pacific Motorway. The development precinct is limited to the portion circled in red in Figure 2, located between The Saddle Road and Gulgan Road.

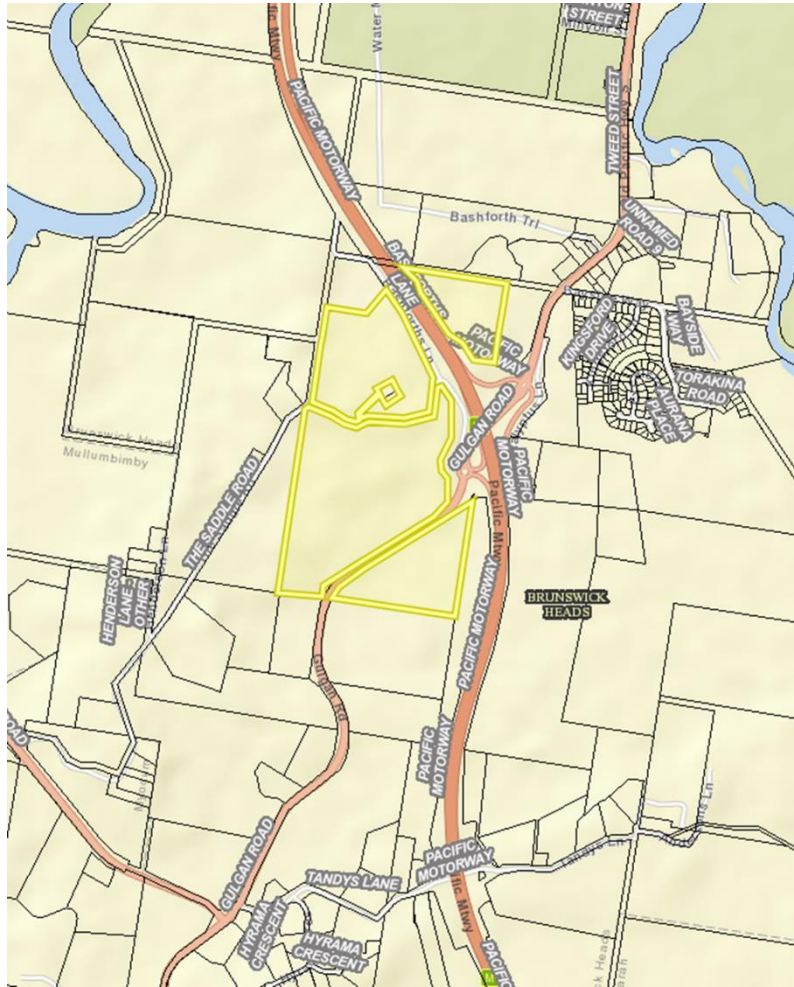

Figure 1 | Site location, Source of the map: Byron Shire Council Online Maps



Figure 2 | Development precinct, Source aerial image: Byron Shire Council Online Maps

1.6. Proposed development

The main goal of the proposal is the implementation of the 2020 Byron Shire Council Business and Industrial Lands Strategy, for Area 5. In line with the Byron Shire Business and Industrial Lands Strategy (BILS) October 2020, the proposal is divided into 2 separate precincts, Area A and Area B, as shown in Figure 3. The 'preferred role' for these precincts as described in the BILS is:

- Business Type Development in Area A: business park type development – buildings housing multiple small businesses.
- Traditional Industrial Estate zone in Area B: allowing larger footprints for warehouse style uses requiring truck manoeuvring.



Figure 3 | BILS Area 5, Source: Byron Shire Council

The proposed Area 'A', 4.95 hectares, has been earmarked for a business park type development and 'B', 1.55 hectares, as a traditional industrial estate. Area A encompasses the entire top precinct, whereas Area B is split on either side of the Rous Water Main leaving a corridor for a future access road.

The two precinct areas are distinctly different in topography Area A is elevated, roughly between 30m and 40m AHD. Area B is lower, with elevations approximately between 4m AHD and 6m AHD.

The key element of the proposal from a traffic engineering aspect is the access to the site. Access via The Saddle Road has been explored previously however it is acknowledged to potentially substantially impact existing vegetation and was agreed to be inappropriate by both Council and the proponent for that reason. All traffic will be via Gulgan Road.

Four intersection options will be investigated for Gulgan Road:

- Option A – Left in / left out only in conjunction with a roundabout at Uncle Tom's.
- Option B – Roundabout
- Option C – signalised intersection.
- Option D – channelised intersection

2. EXISTING CONDITIONS

2.1. Subject site

The subject site proposed for this Planning Proposal is a portion of Lot 2 DP 1159910 (see Figure 1). Access can be obtained directly from Gulgan Road, which places the development on an existing public transport route and in close proximity to direct northbound and southbound ingress and egress to the Pacific Highway.

The site is situated between the towns of Mullumbimby and Brunswick Heads. It is expected that the majority of traffic to and from the site will be generated from these areas. Traffic from Mullumbimby to the Pacific Highway will travel past the site if headed north (or returning from the north) as does traffic between Brunswick Heads and Mullumbimby. Traffic between Mullumbimby and Byron Bay does not travel past the site.

There is an existing site gate at the location of the proposed T-junction (Figure 4) and as such it is technically not proposed to create a new access point onto Gulgan Road. The development does include a proposal to upgrade the existing entrance and intensify its use on the southern portion of the site.



Figure 4 | Existing site gate

2.2. Gulgan Road traffic surveys

Byron Shire Council have provided our office with a Gulgan Road traffic survey undertaken mid-December 2019. The survey location is 200 metres south of the Brunswick Interchange roundabout.

Since the month during which this data was collected (December) typically has elevated traffic volumes, and traffic profiles may differ from the 'typical' due to some schools having started the holidays, this dataset is of limited use for the purposes of our study.

Table 4 | Gulgan Road traffic survey data (2019)

Gulgan Road (Byron Shire Council data)							
Dates	Wednesday 11/12/19	Thursday 12/12/19	Friday 13/12/19	Saturday 14/12/19	Sunday 15/12/19	Monday 16/12/21	Tuesday 17/12/21
Location	Gulgan Road, 200m south of the roundabout, 11/12/2019 to 18/12/2019						
Traffic volume	9192	8912	9133	7575	6752	9269	9413
AM peak hour time	8:00 - 9:00	8:00 - 9:00	8:00 - 9:00	10:00 - 11:00	10:00 - 11:00	8:00 - 9:00	8:00 - 9:00
	798	785	802	711	603	789	838
PM peak hour time	16:00 - 17:00	16:00 - 17:00	15:00 - 16:00	12:00 - 13:00	12:00 - 13:00	16:00 - 17:00	15:00 - 16:00
	767	814	766	669	613	798	827
5-day ADT	9184	AM average peak (weekday)		802	% heavy vehicles		6.41%
7-day ADT	8607	PM average peak (weekday)		794	85%-ile speed		78 km/h

In order to provide a better baseline for this study, our office carried out a 7-day vehicle count adjacent the existing site gate on Gulgan Road using a RoadRunner3 vehicle classifier which was placed next to the 80 km/hr sign on Gulgan Road, as shown on the photos in Figure 5. This is approximately 80 metres south of the 2019 Byron Shire Council survey location. The survey was carried out from Wednesday the 28th of July 2021 to Tuesday the 3rd of August 2021. During this period there were no covid-related lockdowns in place in the Byron Shire.



Figure 5 | Traffic counter location, source Google Maps

A summary of the survey results is provided in Table 5 below.

Table 5 | Gulgan Road traffic survey data (2021)

Gulgan Road							
Dates	Wednesday 23/07	Thursday 29/07	Friday 30/07	Saturday 31/07	Sunday 01/08	Monday 02/08	Tuesday 03/08
Location	Gulgan Road, 320m south of the roundabout at 80km/h sign, 28/07/2021 to 03/08/2021						
Traffic volume	8192	8630	9075	7104	6163	7299	7749
AM peak hour time	08:15 - 09:15	08:30 - 09:30	08:00 -09:00	09:45 - 10:45	11:45 - 12:45	08:15 - 09:15	07:15 - 08:15
	810	784	793	696	622	749	794
PM peak hour time	15:15 - 16:15	15:30 - 16:30	15:00 - 16:00	13:00 - 14:00	13:00 - 14:00	14:30 - 15:30	15:15 - 16:15
	818	826	851	610	625	678	767
5-day ADT	8189	AM average peak (weekday)		786	% heavy vehicles		7.50%
7-day ADT	7745	PM average peak (weekday)		788	85%-ile speed		91 kph

A further traffic study in the same location was carried out early September 2022, in order to verify the 2021 data that was collected during the pandemic (albeit outside of lockdowns). These results are summarised in Table 6 and on the basis of these the 2021 results are verified as suitable to be used for this report.

Table 6 | Gulgan Road traffic survey data (2022)

	Gulgan Road						
Dates	31/08/2022	1/09/2022	2/09/2022	3/09/2022	4/09/2022	5/09/2022	6/09/2022
	Wednesday	Thursday	Friday	Saturday	Sunday	Monday	Tuesday
Location	Gulgan Road, 320m south of the roundabout at 80km/h sign						
Traffic volume	8307	8670	8658	5679	4666	7944	7974
AM peak hour time	8:15 - 9:15	8:00 - 9:00	8:15 - 9:15	11:00 - 12:00	11:45 - 12:45	8:15 - 9:15	8:30 - 9:30
	819	827	826	579	458	786	748
PM peak hour time	15:00 - 16:00	15:15 - 16:15	15:00 - 16:00	12:00 - 13:00	12:00 - 13:00	15:15 - 16:15	14:45 - 15:45
	810	823	737	509	454	794	803
5-day ADT	8282	AM average peak (weekday)		801.2	% heavy vehicles		3.99%
7-day ADT	7391	PM average peak (weekday)		793	85%-ile speed		92.2

2.3. Intersection surveys

Traffic Data & Control (TD&C) have carried out intersection turning movement surveys at the locations shown in Figure 6. The survey results are provided in Appendix A.

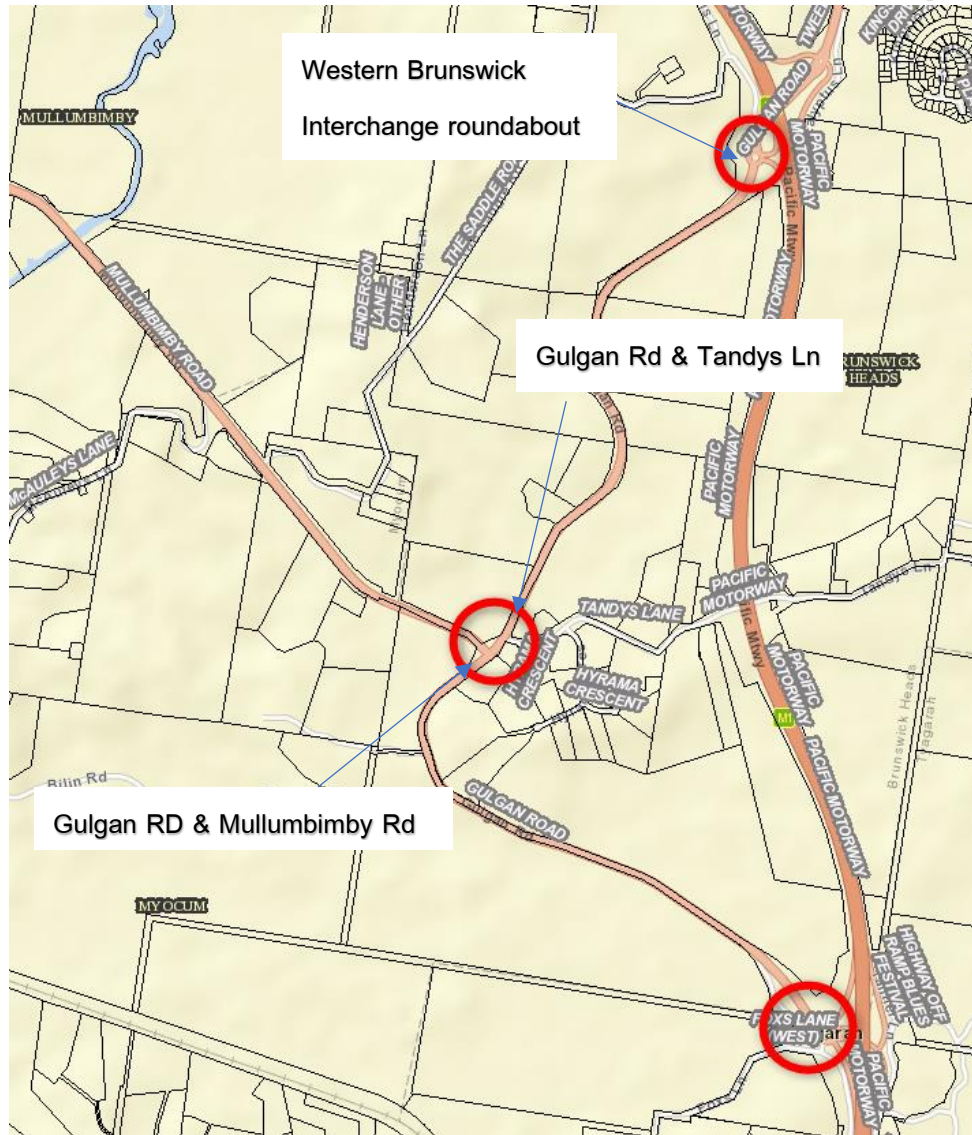

Figure 6 | Intersections' survey locations

Western Brunswick Interchange roundabout (see Figure 7): Roundabout located directly north of the subject site entrance.

Gulgan Rd & Tandys Lane, (see Figure 8): Intersection located to the south of the subject site, just north of the intersection with Mullumbimby Road.

Gulgan Rd & Mullumbimby Rd, (see Figure 8). Intersection located to the south of the subject site, adjacent the intersection with Tandys Lane. Concept design and investigations for an upgrade of this intersection to a roundabout are scheduled for the financial year of 2024/25 in Byron Shire Council's Capital Works Program.



Figure 7 | Western Brunswick Interchange Roundabout survey location, Source: BSC online maps



Figure 8 | Gulgan Rd & Mullumbimby Rd & Tandy's In intersections, Source: BSC online maps

2.4. Gulgan Road

Byron Shire Council's Online Maps designates Gulgan Road as a Regional Road. Gulgan Road is not listed as a B-double Route on the interactive mapping system of Transport for NSW. Gulgan Road is

classified Regional on the Transport Roads & Maritime Services Schedule of Classified and Unclassified Regional Roads and has gazetted road number MR463.

At the subject site frontage, Gulgan Road has a sealed pavement width of 11 meters, carriageway width of 6 meters, the speed limit varies between 60 km/hr and 80 km/hr due to the change in posted speed limit directly in front of the site.

2.5. Existing crash statistics

Gulgan Road crash statistics between 2015 and 2019 were extracted from the Transport for NSW website and shown in Figure 9 below. The crash statistics provide us with the number of car crashes between that period, the degree of the crash, location, and period of the day.

Four out of eight crashes occurred at an intersection, and the remaining four on the undivided carriageway. The undivided carriageway crashes were associated with a pedestrian walking on the road in the dark, a car hitting an object on the side of the road, a car doing a U-turn and a rear-end. The likelihood of pedestrians or cyclists being involved with crashes should reduce as a result of Council's Byron Shire Pedestrian Access & Mobility Plan, if designed and constructed to an adequate standard.

The crashes at the Mullumbimby Road intersection highlight the need for this intersection to be upgraded by Council, irrespective of this development. The SIDRA modelling in this report further demonstrates that this intersection is not performing at an adequate Level of Service during peak hour conditions.

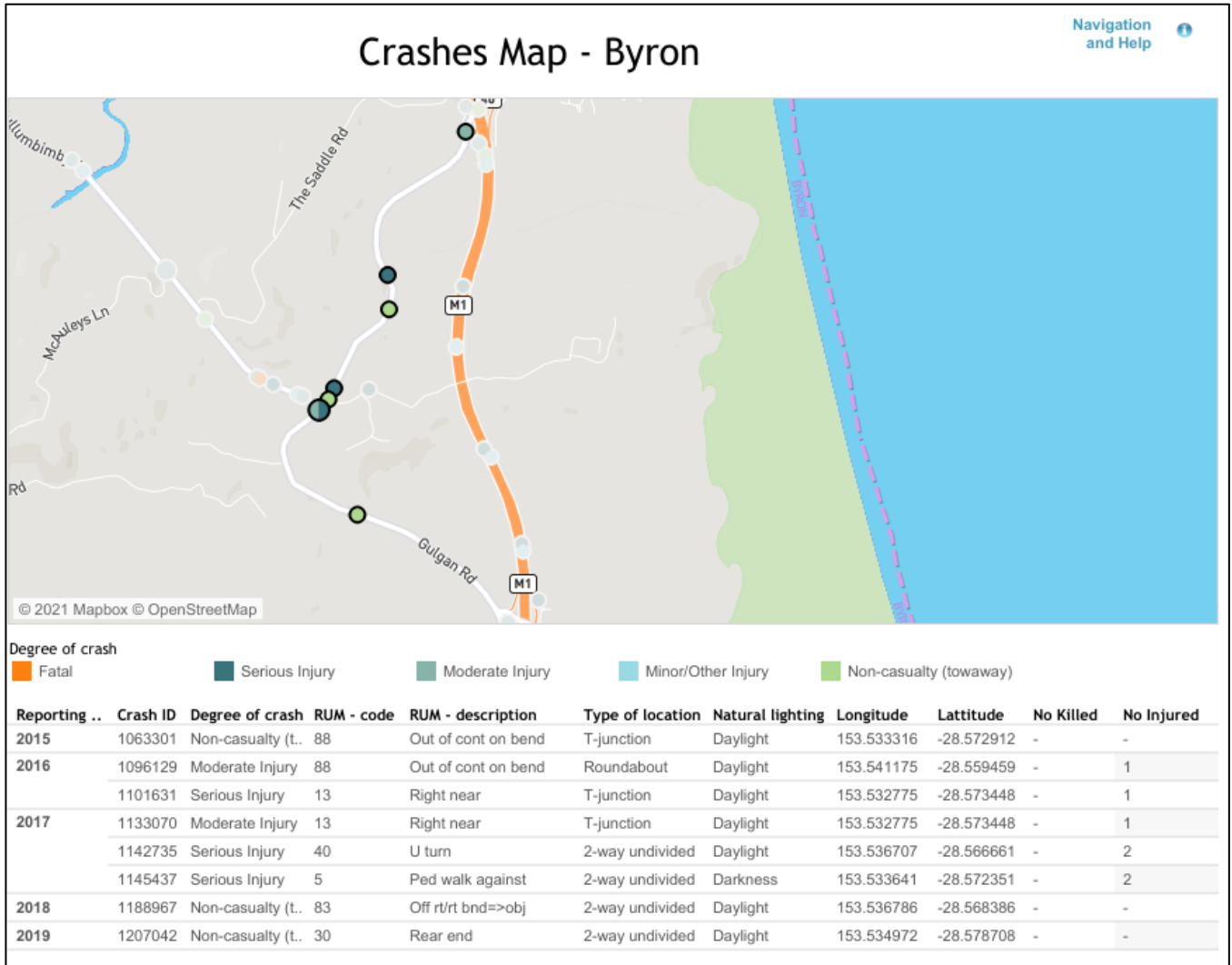

Figure 9 | Cashes data on Gulgan Road since 2015, Source: Transport for NSW

3. PROPOSED DEVELOPMENT

3.1. Development description

The goal of the proposal is the implementation of the 2020 Byron Shire Council Business and Industrial Lands Strategy, for Area 5. In line with the Byron Shire Business and Industrial Lands Strategy (BILS) October 2020, the proposal is divided into 2 separate precincts, Area A and Area B, as shown in Figure 10. The 'preferred role' for these precincts as described in the BILS is:

- Business Type Development in Area A: business park type development – buildings housing multiple small businesses.
- Traditional Industrial Estate zone in Area B: allowing larger footprints for warehouse style uses requiring truck manoeuvring.



Figure 10 | BILS Area 5, Source: Byron Shire Council

The BILS zoning concept is depicted in Figure 10. The proposed development is a Planning Proposal to enable Area A to be rezoned for Business Park and Area B for Traditional Industrial uses.

The zoning concept is provided by Creative Capital, where area 'A', 4.95 hectares, has been earmarked for a business park type development, typically zoned as business park, and 'B', 1.55 hectares, as a traditional industrial estate. Area A encompasses the entire top precinct, whereas Area B is split on either side of the Rous Water Main and leaves a corridor for a future access road.

The two precinct areas are distinctly different in topography. Area A is elevated, roughly between 30m and 40m AHD. Area B is lower, with elevations approximately between 4m AHD and 6m AHD.

The key element of the proposal from a traffic engineering aspect is the access to the site. All access will be via Gulgan Road. There is an existing site gate on Gulgan Road, which marks the approximate location of the proposed access intersection. Four intersection options are assessed in this report. These are described in the next section.

3.2. Proposed intersections

The four intersection options to be analysed are:

- Option A – Left in / left out only. This would be subject to the construction of a roundabout at Uncle Tom's, which is funded to the design stage by Byron Shire Council with potential construction funding by the Northern Rivers Reconstruction Corporation.
- Option B – Roundabout. Analyse the most efficient roundabout configuration studied to date (which is a single lane roundabout with southbound traffic bypass and separate left and right turning lanes from site) in order to minimise the potential for queuing back to the Brunswick Heads overpass.
- Option C – Signalised intersection. This option requires minimal disturbance of land, has the least impact on vegetation, but is the most contentious of the four.
- Option D – Channelised turn. This option has been designed specifically to avoid any tree removal with the Biodiversity Values Mapping layer, whilst staying clear from the Rous water mains.

Each of these 4 options will be investigated in relation to the following topics:

- Intersection efficiency – queuing and delays on Gulgan Road
- Works footprint
- Impact on vegetation – in particular associated tree removal if any
- Construction cost
- Safety profile

All these four intersection options have been designed and analysed for a 60 km/h speed environment. Liaison with TfNSW about moving the transition of 80 km/h to 60 km/h further west has commenced, a record of which is provided in Appendix E.

3.3. Main access road

Design specifications of the main access road are not required as part of this proposal. These details will be provided in future applications, after approval of the subject Planning Proposal.

3.4. Trip generation for Traditional Industrial area

Two traffic generation surveys have been carried out to assist with determining trip generation rates for a Traditional Industrial Area.

The first survey was carried out at the Russellton Industrial Estate in Alstonville. With a developed area of 28.35 hectares, it provides a large sample size for the typical traffic generation of an IN1 General Industrial zone in the Northern Rivers of NSW.

The Russellton Industrial Estate is located off Lismore Road, between Alstonville and Wollongbar (see Figure 11). Since there is only one access road to the estate (Kays Lane) it provides a premium opportunity for surveying the entire estate without need of allowing for other access roads or additional developments behind the estate.



Figure 11 | Traffic survey area, IN2 zone in Alstonville, source Google Earth Pro.

The Russellton Industrial Estate contains a large variety of uses, typical to the 'permitted with consent' land uses listed in the Ballina LEP for this zone. The list below is not comprehensive, but a sample of current business types in the estate:

- Timber yard
- Rainwater tank manufacturing
- Car mechanics
- Tile shops
- Timber yard
- Earthworks depot
- Indoor sports facilities
- Self-storage units
- Crematorium
- Landscape material supplies
- Take away café
- Hairdresser

Figure 12 shows the area calculation for the estate and depicts the survey location.

The survey results are summarised in Table 7. In summary, the trip generation rates are:

- 7-day ADT rate: 98.5 trips/hectare
- AM peak hour rate: 12.2 trips/hectare
- PM peak hour rate: 13.2 trips/hectare



Figure 12 | Russellton Industrial Estate in Alstonville, Source: Ballina Intramaps 2021

Table 7 | Russellton Industrial Estate survey results

Russellton Industrial Estate IN1 traffic survey							
Dates	Wednesday 28/07	Thursday 29/07	Friday 30/07	Saturday 31/07	Sunday 01/08	Monday 02/08	Tuesday 03/08
Location	Keys Lane, at 50km/h sign, 330m south of Lismore Road, 28/07/2021 to 03/08/2021						
Data from the traffic survey							
Traffic volume	3730	3525	3523	1230	520	3533	3482
AM peak hour time	06:45 - 07:45	08:00 - 09:00	08:15 - 09:15	10:00 - 11:00	11:30 - 12:30	08:15 - 09:15	08:15 - 09:15
	336	351	351	202	55	351	342
PM peak hour time	15:30 - 16:30	15:00 - 16:00	14:30 - 15:30	13:15 - 14:15	15:00 - 16:00	15:30 - 16:30	15:30 - 16:30
	428	375	337	105	46	342	390
Calculated rates							
5-day ADT	3559	Developed area, ha		28.35	% heavy vehicles		25%
7-day ADT	2792	7-day ADT rate (trip/ha)		98.48			
Weekday AM average	346	AM peak rate (trip/ha)		12.21	PM peak rate (trip/ha)		13.21
Weekday PM average	374						

The second traffic survey was of the Manns Road Industrial Estate in Mullumbimby. It is a smaller estate (8.2 hectare developed area) and therefore more sensitive to statistical anomalies. We installed a counter at both ends of Manns Road to allow us to isolate the industrial area from the rugby club. The advantage of the Manns Road Industrial Estate data is that it is in the same Shire as the subject site and therefore may produce a result that is a closer resemblance of what future traffic would be generated at the subject site.

An aerial photo of the Manns Road Industrial Estate with a measurement of the developed land area is shown in Figure 13. It includes an indication of where the two traffic survey tube locations are.

The traffic survey location at the Manns Road entry was taken close to the intersection with Mullumbimby Road as the pavement condition closer to Towers Drive was of such bad quality that it was not suitable for road screws.

The survey results are summarised in Table 8. The calculated trip generation rates are:

- 7-day ADT rate: 250.5 trips/hectare
- AM peak hour rate: 30.9 trips/hectare
- PM peak hour rate: 28.4 trips/hectare



Figure 13 | Manns Road survey, Aerial image by Byron Shire Council online mapping

It is apparent that the ‘per hectare’ trip generation rates at Manns Road are approximately 2.5 times larger than at the Russellton Industrial Estate.

One reason for this may be that the Manns Road survey was carried out mid-December, which is usually a busier time of the year. Since we undertook a peak hour traffic survey at the Manns Road intersection with Mullumbimby Road in April 2021, the peak hour results can be compared to that sample to verify this explanation.

The intersection turning survey was carried out on Thursday, the 22nd of April 2021. During the AM peak, 252 vehicles travelled on Manns Road adjacent the intersection and during the PM peak this number was 300. These numbers are of a similar order of magnitude as the 287 and 284 (resp.)

recorded on the Thursday of our 7-day classified counter survey. Therefore, seasonal effects are not sufficient to explain the large difference between the Mullumbimby and Alstonville sites.

Table 8 | Manns Road survey results

Manns Road 1							
Dates	Saturday 11/12	Sunday 12/12	Monday 13/12	Tuesday 14/12	Wednesday 15/12	Thursday 16/12	Friday 17/12
Location	Manns Road at the speed sign near the intersection with Mullumbimby Road						
Traffic volume	1382	1317	2856	2980	3011	2948	3003
AM peak hour time	11:00:00 AM	11:00:00 AM	8:30:00 AM	8:15:00 AM	8:30:00 AM	8:15:00 AM	10:15:00 AM
	124	99	272	273	287	307	310
PM peak hour time	2:00:00 PM	4:00:00 PM	2:45:00 PM	2:45:00 PM	3:15:00 PM	2:15:00 PM	3:45:00 PM
	96	134	266	270	284	280	237
5-days ADT	2960	Weekday AM average peak		290	% heavy vehicles		
7-days ADT	2500	Weekday PM average peak		267	85%-ile speed		
Manns Road 2							
Dates	Saturday 11/12	Sunday 12/12	Monday 13/12	Tuesday 14/12	Wednesday 15/12	Thursday 16/12	Friday 17/12
Location	Manns Road near the entry to the Rugby Club						
Traffic volume	447	634	346	404	324	314	616
AM peak hour time	11:00:00 AM	11:00:00 AM	8:30:00 AM	8:15:00 AM	8:30:00 AM	8:15:00 AM	10:15:00 AM
	32	40	30	13	23	19	95
PM peak hour time	2:00:00 PM	4:00:00 PM	2:45:00 PM	2:45:00 PM	3:15:00 PM	2:15:00 PM	3:45:00 PM
	36	75	38	36	35	18	42
5-days ADT	401	Weekday AM average peak		36	% heavy vehicles		
7-days ADT	441	Weekday PM average peak		34	85%-ile speed		
Manns Road 1 - Manns Road 2							
5-days ADT	2559		Weekday AM average peak		254		
7-days ADT	2059		Weekday PM average peak		234		
Manns Road industrial estate totals							
5-days ADT rate (trip/ha)	311.29		Weekday AM peak rate (trip/ha)		30.88		
7-days ADT rate (trip/ha)	250.47		Weekday PM peak rate (trip/ha)		28.42		

For the remainder of the report, we will adopt the precautionary principle and use the Manns Road survey results to estimate development trip generation.

Using the proposed traditional industrial footprint of 1.55 hectares, the following trip generation can be calculated for the traditional industrial precinct:

- Proposed 7-day ADT: Proposed area (1.55) x 7-day ADT rate (250) = **388 trips/day**
- Proposed AM peak: Proposed area (1.55) x AM peak rate (30.9) = **47.9 trips/hr**
- Proposed PM peak: Proposed area (1.55) x PM peak rate (28.4) = **44.0 trips/hr**

3.5. Trip generation for Business Park

Our office used the same method applied for the Traditional Industrial zone situation, explained above, to estimate the generated traffic that the proposed business park zone would add in the existing road network. We carried out a 7-days vehicle survey at Habitat in Byron Bay (see Figure 14 and Figure 15). We placed two counters on Wallum Place, the first between Bayshore Drive and Porter Street and the second one west of Gallagher Street, near the Byron STP site. The difference between the two counters provides the traffic generated by Habitat. The two surveys were not carried out simultaneously, but since this is about applying averages representing typical use, the difference in timing should not affect the outcomes of the study.



Figure 14 | Traffic survey area, B4 zone in Byron Bay, *Source Google Earth Pro*



Figure 15 | Traffic survey area in Byron Bay, source Byron Shire Council Online Map

The survey results are provided in Table 9 and Table 10. In Table 10, Byron STP hourly traffic volumes are provided during the Habitat peak hour times, in order to assist with the calculation of the Habitat peak hour volumes with the STP excluded.

At the time of the survey, Habitat was not yet fully developed. Based on data provided by the developer and our own estimates using aerial imagery combined with site visits, the area developed at the time of the survey is estimated at 3.54 hectares (Figure 16). This area will be used to calculate the trip generation rates.



Figure 16 | Habitat developed area, Source: Byron Shire online mapping 2021

Table 9 | Habitat traffic survey data summary

Habitat							
Dates	Saturday 01/05	Sunday 02/05	Monday 03/05	Tuesday 04/05	Wednesday 05/05	Thursday 06/05	Friday 07/05
Location	Wallum Place, 30m northwest of Bayshore Dr, 01/05/2021 to 07/05/2021						
Traffic volume	1705	988	2584	2701	2807	2808	2712
AM peak hour time	11:15 - 12:15	10:30 - 11:30	09:30 - 10:30	09:45 - 10:45	09:45 - 10:45	10:00 - 11:00	09:00 - 10:00
	198	143	300	312	288	288	273
PM peak hour time	13:30 - 14:30	13:30 - 14:30	13:30 - 14:30	13:30 - 14:30	13:00 - 14:00	13:30 - 14:30	14:30 - 15:30
	201	120	242	252	270	269	271
5-days ADT	2159	Weekday AM average peak		292	% heavy vehicles		14%
7-days ADT	2329	Weekday PM average peak		261	85%-ile speed		32 kph

Table 10 | Byron STP & Byron Bay Herb Nursery data

Byron STP							
Dates	Thursday 01/07	Friday 02/07	Saturday 03/07	Sunday 04/07	Monday 05/07	Tuesday 06/07	Wednesday 07/07
Location	Wallum Place, 150m from Byron STP, 01/07/2021 to 07/07/2021						
Traffic volume	196	206	36	56	168	263	204
Habitat AM peak hour time	11:15 - 12:15 7	10:30 - 11:30 19	09:30 - 10:30 5	09:45 - 10:45 4	09:45 - 10:45 17	10:00 - 11:00 19	09:00 - 10:00 24
Habitat PM peak hour time	13:30 - 14:30 30	13:30 - 14:30 34	13:30 - 14:30 4	13:30 - 14:30 13	13:00 - 14:00 11	13:30 - 14:30 23	14:30 - 15:30 21
5-days ADT	207	Weekday AM average peak		17	% heavy vehicles		85%
7-days ADT	161	Weekday PM average peak		24	85%-ile speed		76kph

Table 11 | Habitat calculated trip generation rates

Traffic data from Habitat minus traffic data from Byron STP			
5-days ADT	1952	AM average peak	275
7-days ADT	2168	PM average peak	237
Habitat calculated trip generation rates			
5-days ADT rate (trip/ha)	551.41	AM peak rate (trip/ha)	77.68
7-days ADT rate (trip/ha)	612.43	PM peak rate (trip/ha)	66.95

The proposed business park precinct area is 4.95 hectares. On this basis, the trip generation of the business park precinct is estimated at:

- 7-day ADT: $4.95 \times 612.43 = 3031$ trips per day
- Weekday AM peak: $4.95 \times 77.68 = 385$ trips per hour
- Weekday PM peak: $4.95 \times 66.95 = 331$ trips per hour

3.6. Development trip generation

Combining the trip generation of both the Traditional Industrial precinct and the Business Park precinct, the combined traffic generation can be calculated as shown in Table 12.

Table 12 | Development trip generation

Parameter	Traditional Industrial	Business Park	Combined
7-day ADT	388	3031	3419
AM peak hour	47.9	385	433
PM peak hour	44.0	331	375
% heavy vehicles	25%	8.7%	10.5%

These values will be adopted as core rates for estimating the impact of the development on the adjacent road network.

Based on a review of the survey data for Habitat and Kays Lane, we will adopt that during the AM peak, 60% of traffic generated is inbound and 40% outbound, which reverses during the PM peak.

3.7. The Saddle Road

The proposal in this report is to avoid any increase of traffic to The Saddle Road. We propose no connection of the subject development to The Saddle Road. There are two key reasons for this:

1. The intersection of The Saddle Road with Mullumbimby Road has significant sight distance issues. There should be no intensification of traffic at this intersection until a suitable long term solution has been implemented by Council. A short term solution would be to reduce the posted speed limit to a value adequate for the currently available sight distance. A long term solution would be to alter the intersection to a compliant intersection.
2. Increasing traffic volumes on The Saddle Road may trigger widening of its carriageway. Widening of the carriageway may result in significant vegetation removal.

Therefore all development traffic is limited to the site entrance discussed in this report. Any future proposals that increase traffic volumes on The Saddle Road should address the above two issues.

4. TRAFFIC IMPACT PARAMETERS

This chapter outlines the determination of key parameters to study the impact of the four intersection options. The following four chapters implement these parameters for the option study.

4.1. Design horizon

Further to discussions with Council, the following parameters are set for calculating the design horizons:

- Starting year: 2024
- Design horizon new intersections (other than roundabouts) and all existing intersections (including roundabouts): 10 years – Design year: 2034
- Design horizon new roundabouts: 20 years – Design year 2044.

For comparison purposes, we will analyse all intersections for the 2034 and the 2044 scenarios. This creates a fair comparison between intersection options.

4.2. Traffic scenarios

The following three traffic scenarios are adopted for further analysis of existing intersections.

1. Starting year existing background traffic, no development traffic
2. Design year 2034 predicted background traffic, no development traffic
3. Design year 2034 predicted background traffic plus development traffic.

The following traffic scenarios are adopted for the proposed access intersection:

- 2034 background plus design traffic
- 2044 background plus design traffic

4.3. Historic trends

Historic traffic growth is traditionally used to estimate future growth using extrapolation. We submitted a query for historical traffic survey data at several stations between Mullumbimby and Brunswick Heads to Byron Shire Council. The station with the best data set was selected for further analysis. This is the traffic count station on Mullumbimby Road, 500 metres west of the Gulgan Road intersection. It is assumed that traffic growth trends at this station are representative of traffic growth trends elsewhere on the road network under consideration.

There are two common approaches to establishing traffic growth rates:

1. Annual compound growth rates, and
2. Linear growth.

Annual compound growth calculates the traffic volume each year has grown with a pre-determined percentage per year from an assumed baseline year and volume. Linear growth is considered a percentage of a selected base year and volume, where constant absolute growth is assumed each year.

We have calculated trend lines for both options and made a selection of the most appropriate method below.

These trends have been optimised for base-year volume and growth rate (as a percentage of base year volume). These parameters are depicted in Table 14. The R² value in this table represents the accuracy of the trendline. This analysis shows that for the data available, the results from both the linear method and the compound method are very close in accuracy, 98.14% and 98.19%, respectively. From the graph in Figure 17. In this figure the adopted AADT values are calculated from Council's traffic data for Mullumbimby Road and adjusted using the seasonal factors calculated in Figure 37 to allow for the different times of year the Council surveys were undertaken., see Table 13.

It would appear that future growth is likely underestimated if the linear method is adopted. The linear method would be useful for interpolation within an existing survey range, but appears less likely to be accurate for long-term forecasting and extrapolation. From our experience with other projects and trends in the area, we will continue using the **annual compound method** and a growth rate of **3.35%**. This percentage will be applied using 2021 survey data as the new baseline dataset.

Table 13 | Mullumbimby Road AADT values

Year	Survey month	7-day ADT	Seasonal factor	AADT
2006	August	8272	1.000	8272
2008	August	8766	1.000	8766
2010	August	9273	1.000	9273
2012	August	9596	1.000	9596
2014	September	10524	1.009	10430
2016	August	11275	1.000	11275
2021	November	13788	1.048	13156

Table 14 | Trend line parameters

	Linear method	Annual compound (exponential) method
Baseline year	2006	2006
Baseline volume	8100	8034
Growth rate	3.90%	3.35%
R ²	97.28%	98.17%

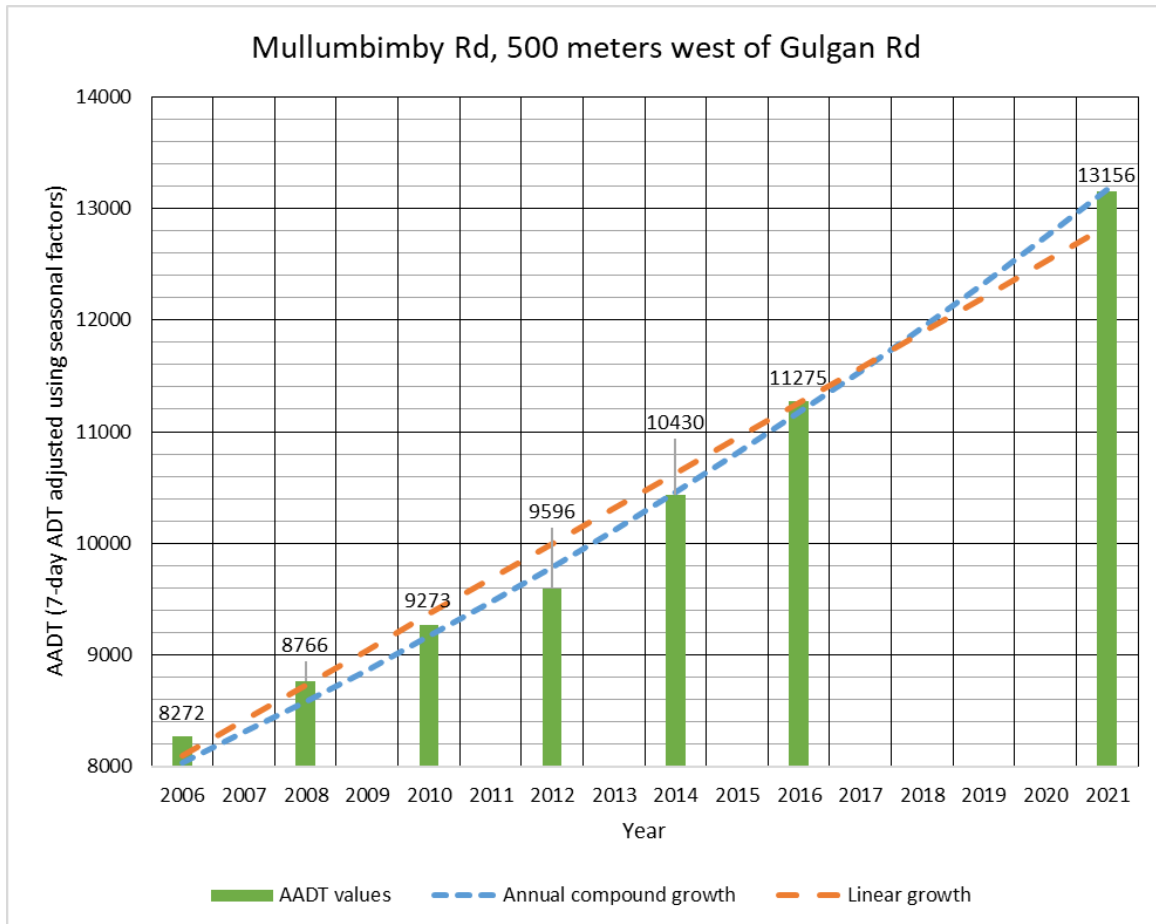

Figure 17 | Mullumbimby Road growth trends

4.4. Covid-19 pandemic impacts on transport modelling

In recognition of the impact of the Covid-19 pandemic restrictions and resulting country-wide lifestyle changes, Transport for NSW have issued a Technical Note to assist with assessing the impact of Covid-19 for business cases. The context of the document is for guidance in undertaking sensitivity testing of Cost-Benefit Analysis (CBA). Although CBA's are not carried out in this Traffic Impact Study, the content of the Technical Note does assist with understanding traffic impacts and potential changes to traffic growth predictions.

The TfNSW Technical Note breaks down the impact of COVID-19 on the transport network into immediate and long-term impacts. It defines these impacts as follows:

- **Immediate:** major reductions in public transport and car trips, reductions in public transport capacity, increased second hand car purchases, increased intrastate visitation, reduction in public transport preference, increased online shopping and deliveries, reductions in overseas and interstate visitors
- **Longer-term:** Reduction in overseas migration, leading to a decrease in NSW and Sydney population growth rates, reducing overall projected travel demand, reduced commuter trips due to more people working from home, changing spatial distribution of interpeak / daily non-commute trips.

Due to the level of uncertainty involved, TfNSW recommends COVID-19 scenarios are included as sensitivity tests only, and not within core results.

In addition to the information provided in the Technical Note, local experience shows that the Northern Rivers of NSW is seeing a significant influx of people moving from metropolitan areas such as Sydney and Melbourne to regional areas. As a result of this the local housing market has seen an unprecedented inflation of real estate prices.

The website www.domain.com.au provides median trend lines for different types of houses since 2017. The trend lines below are for Mullumbimby and Byron Bay, for 3- and 4-bedroom houses. They all demonstrate the pressure on the local real estate market, which is representative of the drive for residents from metropolitan areas to move here, in particular from Sydney and Melbourne.

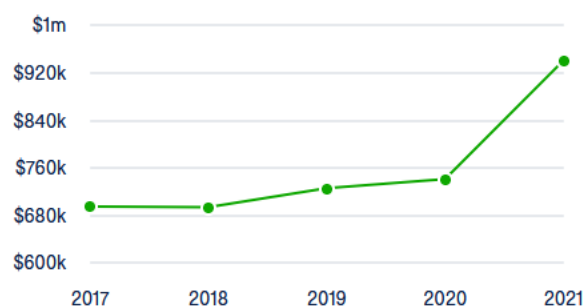

Figure 18 | Median 3-bed house price Mullumbimby, Source: www.domain.com.au

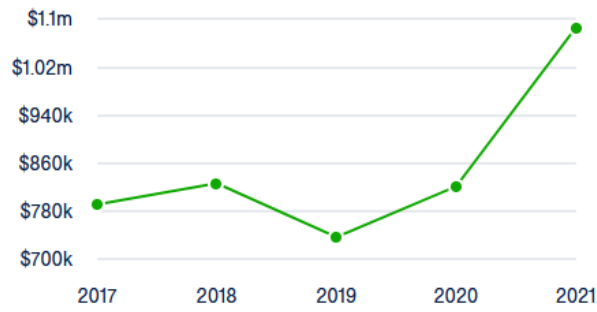

Figure 19 | Median 4-bed house price Mullumbimby, *Source: www.domain.com.au*

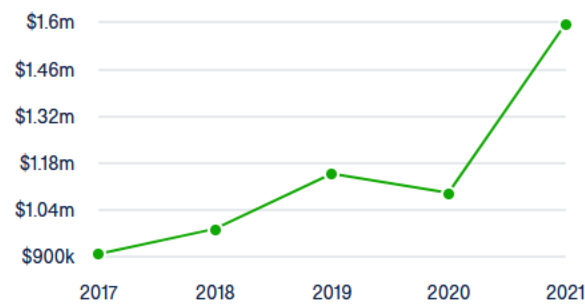

Figure 20 | Median 3-bed house price Byron Bay, *Source: www.domain.com.au*

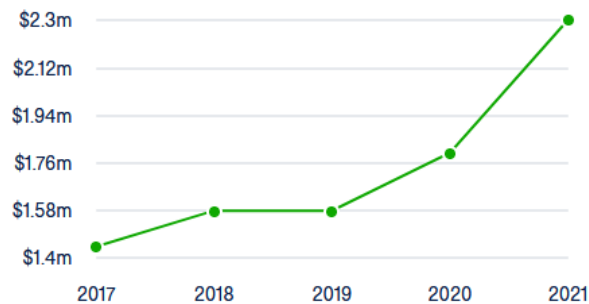

Figure 21 | Median 4-bed house price Byron Bay, *Source: www.domain.com.au*

The above analysis demonstrates the difficulty of predicting and quantifying the impact of pandemic government interventions on traffic growth. Combining the two approaches above, one would expect that locally, the population growth will increase as quick as housing availability allows, but that the migration from the city to the country will not necessarily result in increased peak hour traffic, since those leaving the cities will likely still keep their jobs in the cities and work remote. For this reason, commuting trips may not increase at the same rate as population growth. Other trips, to shops and schools may increase at the same rate, if school capacity keeps up with the demand.

Following TfNSW advice, uncertainties regarding the pandemic impacts will be included in a sensitivity analysis. The core modelling will be carried out using the traditional traffic growth rate prediction method as outlined in section 4.3.

4.5. Byron Shire Residential Strategy

As requested by Byron Shire Council staff, consideration is given to the 2020 Byron Shire Residential Strategy ('the Strategy'), as this may impact on background traffic growth and trip distribution. We note the following disclaimer in the Strategy:

Disclaimer

This document is a final adopted by Council ready for NSW Department of Planning, Industry and Environment consideration. It should not be used as a basis for investment or other private decision making purposes about land purchase or land use. This strategy has no status until formally endorsed by the Department of Planning, Industry and Environment.

The following is noted on Council's website regarding the status of the strategy:

Where are we now?

Council adopted the Residential Strategy at 10 December 2020 Planning meeting. The Strategy has been forwarded to the NSW Department of Planning Industry and Environment (DPIE) for final endorsement.

DPIE has requested a peer review of the strategy to include more consideration of the number of future dwellings and the capacity to deliver these, including impacts of Short Term Rental Accommodation on supply.

The Peer Review started in mid July 2021 and is in the process of being finalised.

Currently, this is a draft strategy, that should not be used for making private investment decisions and it has no status.

The draft strategy contains the following summary of the proposed distribution of new homes:

Table 3: Estimate of Dwelling Yield by Land Supply Type and Locality

Urban locality (map ref)	Existing dwellings (census 2016)	Dwellings commenced 2016-2017 source: Housing and Land Monitor	Approved for residential and zoned vacant	Infill based on current zoning - dispersed locations ^{5.}	Investigation areas	Summary total additional dwelling capacity 2016 - 2036 (rounded)	Total projected dwellings capacity as at 2036 (rounded)
Mullumbimby (1)	1,774 0	37 0	231 0	160 ^{2.} 0	925 ^{3.} 823 ^{4.}	1,355 ^{3.} 1,250 ^{4.}	3,130 2,995
Bangalow (2)	745	32	105	85	96	315	1,065
Brunswick Heads (3)	1,025	9	213	43	0	265	1,290
Byron Bay & Sunrise (4)	3,039	95	800 ^{1.}	113	33	1,040	4,080
Suffolk Park (4)	1,699	in above figure	0	95	0	95	1,795
Ocean Shores, Sth Golden Beach, New Brighton (5)	2,966	55	21	211	0	290	3,255
Combined Urban areas (6)	11,248	228	1,370	707	Range 952 – 1,054	Range 3,250 – 3,355 3,300 as av. (88% of new ^{6.})	Range 14,500 – 14,600 14,550 as av.
Rural areas	4,294	-	-	-	-	430 (12% of new)	4,725
Shire total	15,542	-	-	-	-	3,732	19,275 ^{7.}

Note 1. Based on West Byron providing 650 additional dwellings, it is noted that this figure may be subject to review pending court case determinations

Note 2. Hospital part of infill figure

Note 3. Scenario 1 Yield – based on private landowners for investigation areas using a Residential Strategy R2/R3 diversity lot mix & R1 mix for Council land

Note 4. Scenario 2 Yield – based on all investigation areas using a Residential Strategy R2/R3 diversity lot mix – refer to Policy 2: Table 5 for an explanation

Note 5. These estimates are based on current regulations and anticipated infill take-up range of 10 to 15%.

Note 6. Consistent with Strategy Policy 1 Direction 1.1

Note 7. Aligns with the North Coast Regional Plan 2036 - Figure 10: Minimum housing supply (2016-2036) - Byron Shire; 19,250 dwellings

There is no traffic study that accompanies this strategy. We have therefore carried out our own high-level analysis below.

2013 RMS trip generation rate for dwellings in regional areas (outside their subdivisions) is 7.4 trips per day. The following preliminary calculations can be made regarding the trip generation and distribution (Table 15).

Table 15 | Byron Residential Strategy trip generation

Locality	Summary total additional dwelling capacity	Percentage	Average daily trip generation
Mullumbimby	1355	36%	10027
Bangalow	315	8%	2331
Brunswick Heads	265	7%	1961
Byron Bay & Sunrise	1040	27%	7696
Suffolk Park	95	3%	703
Ocean Shores, South Golden Beach, New Brighton	290	8%	2146

Rural areas	430	11%	3182
Total	3790		28046

Based on this strategy, a total trip generation of 28,000 vehicles per day is estimated, of which 10,000 in and around Mullumbimby. The June 2020 Byron Shire Estimated Resident Population (ERP) as published by the Australian Bureau of Statistics is 35,773. Based on the draft Strategy and the West Byron development, between now and 2036, an additional 3,790 dwellings would be added, equating to approximately 9,475 residents (at 2.5 residents per dwelling, deducted from the 2011 VLC West Byron Development Transport Study). This is an increase of 26.5% over 16 years (2020 to 2036). This equates to a population growth of 1.48% per year (if a gradual release of housing is assumed).

Using the ABS ERP data from 2006 (Figure 22) to 2020, the recorded and predicted population growth in Byron Shire is plotted in Figure 23. In this chart, the 'predicted' population growth is based on the annual growth rate of 1.48%, calculated from the Strategy.

Year (ending June 30)	Number	Change in number	Change in percent	Regional NSW change in percent
2006	30,125	--	--	--
2007	30,174	+49	+0.16	+0.89
2008	30,347	+173	+0.57	+1.01
2009	30,537	+190	+0.63	+1.08
2010	30,664	+127	+0.42	+1.07
2011	30,712	+48	+0.16	+0.80
2012	31,210	+498	+1.62	+0.72
2013	31,756	+546	+1.75	+0.76
2014	32,263	+507	+1.60	+0.81
2015	32,803	+540	+1.67	+0.74
2016	33,399	+596	+1.82	+0.69
2017	34,011	+612	+1.83	+0.85
2018	34,545	+534	+1.57	+0.88
2019	35,075	+530	+1.53	+0.81
2020	35,773	+698	+1.99	+0.83

Source: Australian Bureau of Statistics, Regional Population Growth, Australia (3218.0). Compiled and presented in profile.id by .id (informed decisions).

Figure 22 | Byron Shire historical population numbers, Source: www.profile.id.com.au

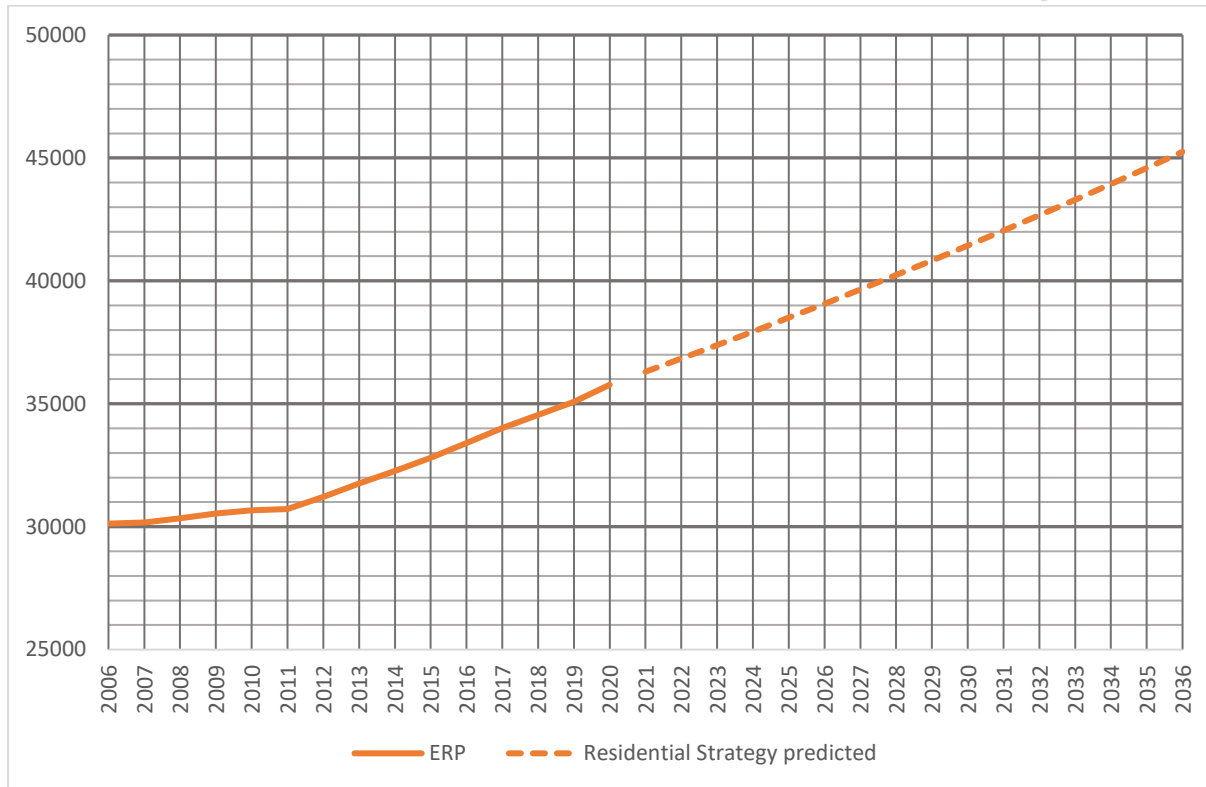

Figure 23 | Shire-wide population growth

For Mullumbimby itself (Figure 24), the ERP growth since 2012 has been an average of 1.9% per year, a little above the Shire wide growth of 1.7%.

Year (ending June 30)	Number	Change in number	Change in percent	Regional NSW change in percent
2012	3,463	--	--	--
2013	3,589	+125	+3.62	+0.76
2014	3,619	+31	+0.86	+0.81
2015	3,659	+40	+1.09	+0.74
2016	3,767	+108	+2.95	+0.69
2017	3,824	+58	+1.53	+0.85
2018	3,894	+70	+1.82	+0.88
2019	3,981	+87	+2.25	+0.81
2020	4,036	+55	+1.37	+0.83

Source: Australian Bureau of Statistics, Regional Population Growth, Australia (3218.0). Compiled and presented in profile.id by [profile.id](http://www.profile.id) (informed decisions).

Please refer to specific data notes for more information

Figure 24 | Mullumbimby historical population numbers, Source: www.profile.id.com.au

These population growth rates are all well below the adopted annual compound traffic growth rate of 3.40%, and therefore do not warrant revision to the intersection modelling carried out in Revision B of this report, as submitted with the Planning Proposal in December 2021.

4.6. Trip distribution

Trip distribution can be estimated by the gravity model according to *T1 Travel Demand Modelling from Australian Transport Assessment and Planning Guidelines*, and the gravity model is a calculation that takes the trips produced in one particular zone and distributes them to other zones based on the size, population, and travel distance.

We adopted a 40 km radius study area and studied the most relevant towns, which would produce trips that future development in this planning proposal area would likely attract. Table 16 below shows the probable destinations and population, travel distance to the site, travel time, and estimated trip produced and attracted to the area in study.

The results are shown in Table 16.

Table 16 | Gravity model

Destination	Route	Population (Census 2016)	Travel distance to town centre (km)	Travel time (min)	Percentage of trips
Lismore (North Lismore + Howards grass + Lagoon Grass + Lismore Heights + East Lismore + Goonellabah + Loftville + Monaltrie + Chilsotts)	Blue	28407	47.9	42	2.65%
Ballina (Ballina+East Ballina+South Ballina+West Ballina)	Blue	17286	37.8	26	4.28%
Banora Point	Red	16167	47.6	31	3.59%
Byron Bay (Byron Bay + Ewingsdale)	Blue	10071	15	14	7.95%
Murwillumbah	Red	9,245	36	31	3.59%
Tweed Heads South, New South Wales	Red	7,615	46.6	30	3.71%
Kingscliff	Red	7,464	45.4	30	3.71%
Pottsville	Red	6,704	26.4	19	5.86%
Lennox Head	Blue	6407	34.9	25	4.45%

Alstonville	Blue	5739	45.3	30	3.71%
Mullumbimby (Mullumbimby+Main Arm)	Green	4182	5.7	7	15.91%
Suffolk Park, New South Wales	Blue	3750	21.3	21	5.30%
Bangalow	Blue	2021	18.40	15	7.42%
Brunswick Heads	Purple	1737	2.90	4	27.84%

The destinations in Table 16 can be reached through the four generalised routes shown in Figure 25. Combining the percentages from Table 16 per route colour, gives the following trip distribution per route for the BILS 5A:

- Red: 20.47%
- Purple: 27.84%
- Blue: 35.78%
- Green: 15.91%

The trip distribution numbers are provided in Table 17.

Table 17 | Development trip distribution volumes

Parameter	Trip generation north of the site – 84.09%	Trip generation south of the site – 15.91%	Total
7-day ADT	2875	544	3419
AM peak hour	364	69	433
PM peak hour	315	60	375

These are plotted in Figure 25. The trip distribution within the red box in this figure varies per option.

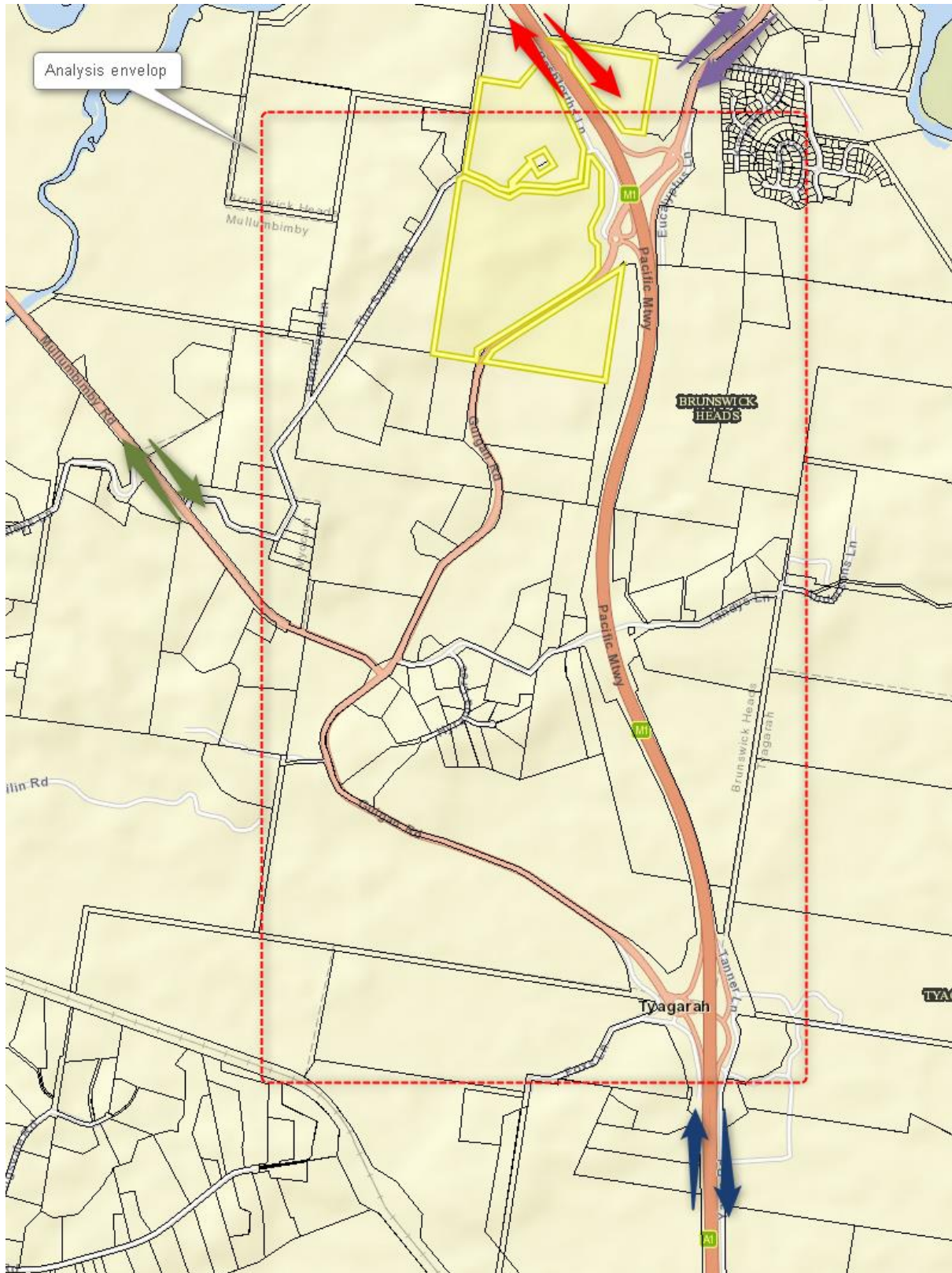

Figure 25 | Travel distribution outside the analysis envelope

5. OPTION A – LEFT IN / LEFT OUT ONLY

The first option to analyse is the left in / left out in conjunction with a roundabout at Uncle Tom's. As no details on this roundabout are available we assume it will be a 2-lane roundabout, to match the existing turning lanes that are at the intersection now.

5.1. Intersection layout

The concept intersection layout is shown in Figure 26 below. The concept includes a short auxiliary left turn lane to remove decelerating vehicles from the through traffic lane and a splitter island + raised central median to physically eliminate right hand turns.

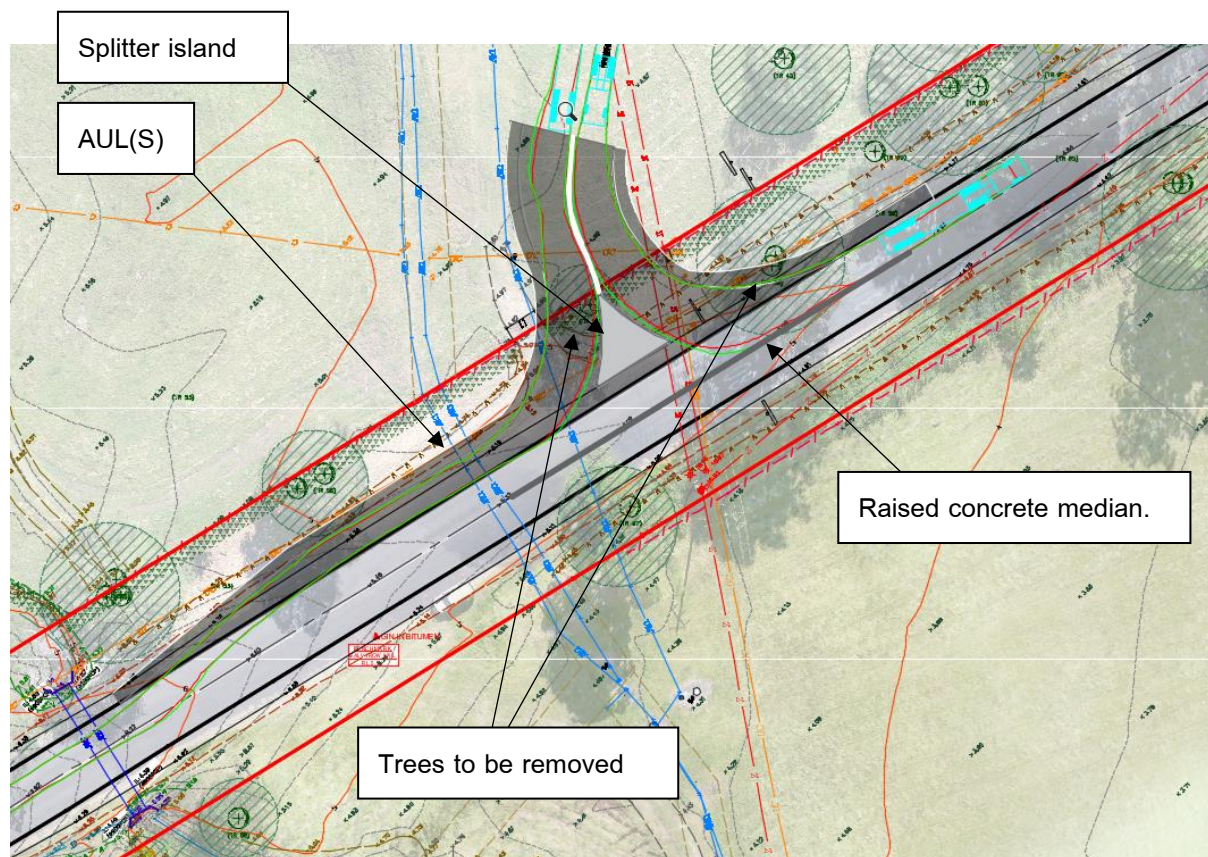

Figure 26 | Option A concept layout

5.2. Trip distribution

All arriving traffic from the north drives past the site and does a U-turn at the new Uncle Tom's roundabout. All arriving traffic from the south arrives from the south. For departure, all traffic headed North, or headed south along the motorway will use the Brunswick Heads roundabout. Traffic bound for Mullumbimby will do a U-turn at the Brunswick Heads roundabout and drive back past the site.

5.3. Intersection performance

This Intersection has been modelled in SIDRA for the 2034 and 2044 scenarios. The diagrammatic layout in SIDRA is shown in Figure 27. All SIDRA modelling results are provided in Appendix G.

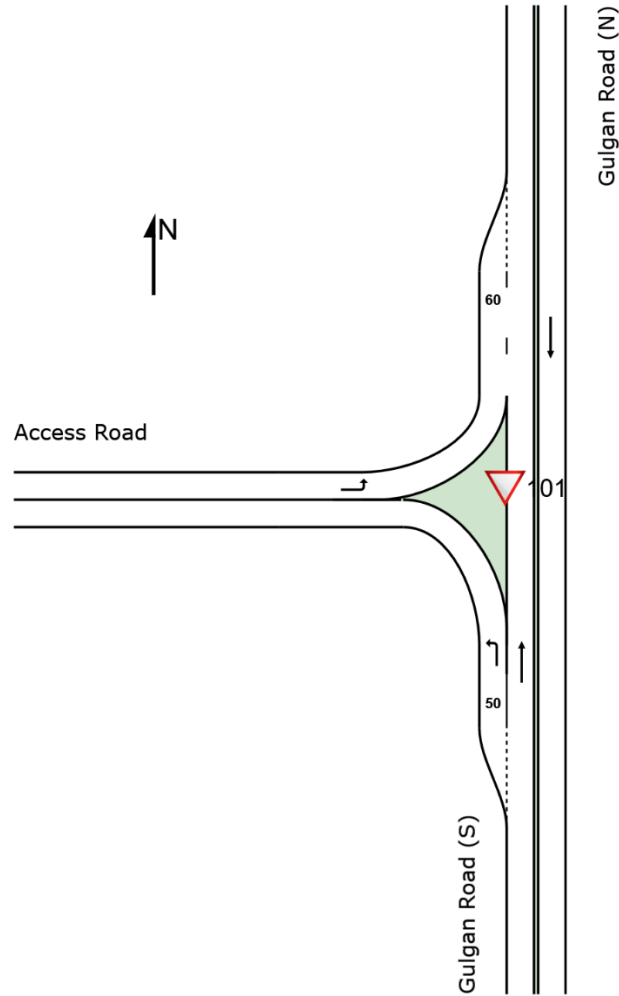

Figure 27 | Access Road intersection Option A

The modelling results for Level of Service have been summarised in Table 18. Only the ‘worst case’ level of service is shown, meaning worst case of all legs and of the AM and PM scenarios combined. As per the previous chapter: all existing intersections are analysed for 2024 and 2034. The new intersection is analysed for 2034 and 2044, so it can be compared to the 20-year design horizon of new roundabouts in the next chapter for Option B. For Tandys Lane the existing intersection layout has been adopted whereas for Mullumbimby Road a new 2-lane roundabout has been assumed as per Council’s instruction for this particular scenario.

Table 18 | Option A Level of Service summary

Intersection	2024 background	2034 background	2034 background + development	2044 background + development
--------------	-----------------	-----------------	----------------------------------	----------------------------------

Access Road	-	-	LOS A	LOS B
Brunswick roundabout	LOS B	LOS B	LOS C	-
Tandys Lane	LOS B	LOS D	LOS F	-
Mullumbimby Road	LOS B	LOS B	LOS B	
Tyagarah roundabout	LOS B	LOS B	LOS B	

This demonstrates that the development triggers an upgrade of the Tandys Lane intersection.

All other intersections perform satisfactorily. Northbound offramp queuing at the Brunswick Roundabout does not exceed 20 metres. Queuing on the overpass does not exceed 118 metres for the 95%-ile queue length, which is acceptable since the length of the overpass between the two roundabouts on either side is approximately 330 metres.

5.4. Impact on vegetation

The construction of this intersection will likely require the removal of two trees of which one (1) is mapped as 'Biodiversity Values Mapping'.

6. OPTION B – ROUNDABOUT

The second option is a single lane roundabout with a southbound Gulgan Road bypass lane to eliminate queueing towards the motorway. The southern approach would have a sliplane into the site to reduce delays for northbound through traffic.

6.1. Intersection layout

A concept layout for the Option B arrangement is shown in Figure 28. It shows a 3-leg single lane roundabout and a southeastbound bypass lane for Gulgan Road through traffic.

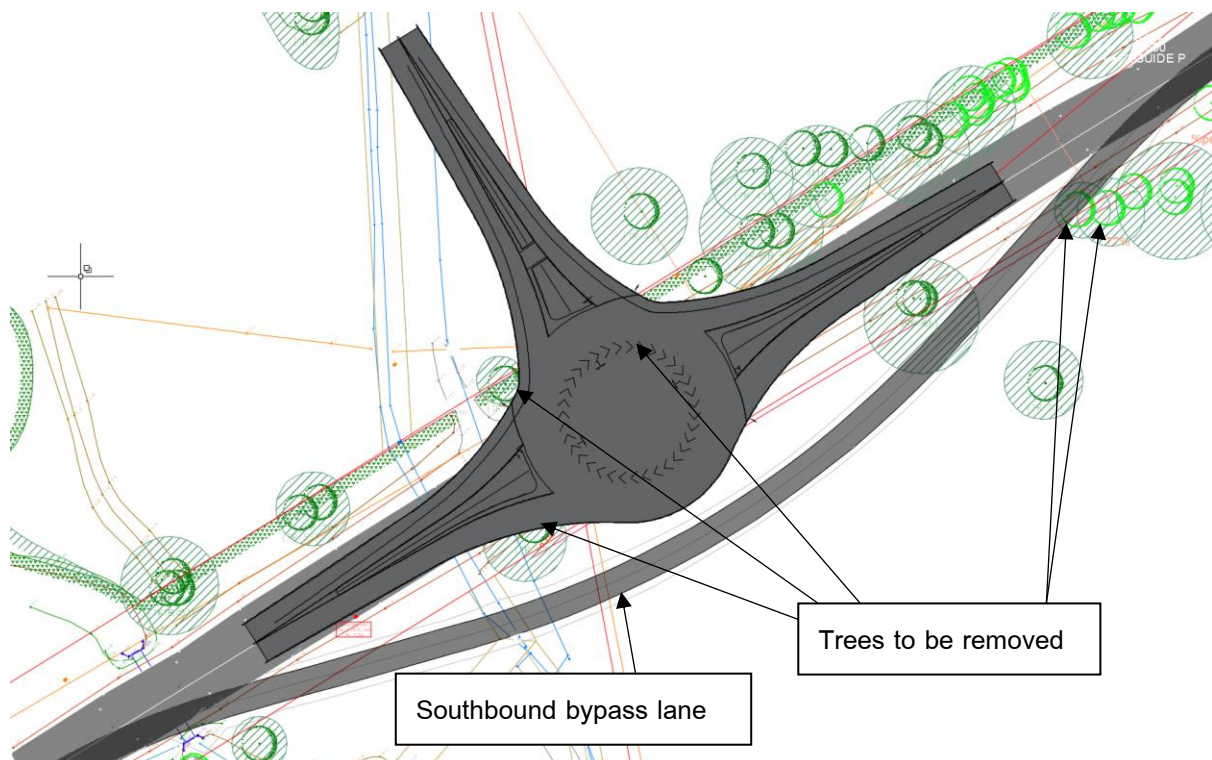

Figure 28 | Option B concept layout

6.2. Trip distribution

The trip distribution assumptions for this option are as follows:

- All Pacific Motorway traffic (north and south) travels to and from the site via the Brunswick Interchange. For southbound traffic this is quicker than travelling south along Gulgan Road to Tyagarah.
- Only Mullumbimby traffic approaches the access intersection from the south.

6.3. Intersection performance

The modelled SIDRA intersection model is shown in Figure 29. All SIDRA modelling results for this option are provided in Appendix H. The Tyagarah interchange is not included as no traffic is generated for that intersection for this option.

The entrance intersection performs satisfactorily for all modelled scenarios. The proposed development triggers an upgrade of the Tandys Lane intersection.

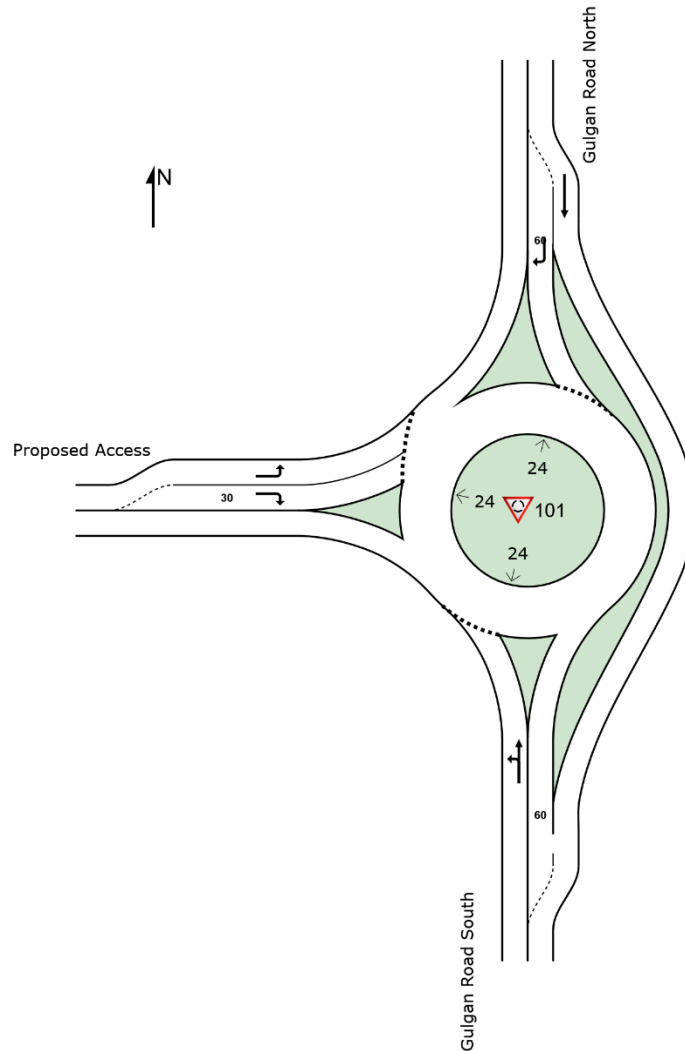

Figure 29 | Option B SIDRA layout

The worst level of service for each scenario is provided in Table 19. The Tyagarah roundabout is not included in this table as it does not carry development traffic in Option B.

Table 19 | Option B Level of Service summary

Intersection	2024 background	2034 background	2034 background + development	2044 background + development
Access Road	-	-	LOS B	LOS B
Brunswick roundabout	LOS B	LOS B	LOS B	-
Tandys Lane	LOS B	LOS D	LOS E	-
Mullumbimby Road	LOS E	LOS F	LOS F	

6.4. Impact on vegetation

This option requires the removal of 5 trees, of which three (3) are mapped as 'Biodiversity Values Mapping'.

7. OPTION C – SIGNALISED INTERSECTION

The Option C intersection is a Signalised T-junction and is analysed in this chapter.

7.1. Intersection layout

Preliminary SIDRA modelling shows that turning lanes are required for all approach legs, to prevent excessive queuing and delays. The concept layout design of the signalised intersection with turning lanes is shown in Figure 30.



Figure 30 | Option C concept layout

7.2. Trip distribution

The trip distribution for this option is identical to that of Option B in the previous chapter.

7.3. Intersection performance

The access intersection performance has been modelled in SIDRA. A schematic of the SIDRA layout is shown in Figure 32. The SIDRA modelling results are provided in Appendix I. This appendix only contains the modelling results for the access intersection. The cycle time has been optimised each scenario, and therefore differs between scenarios. The adopted phases (the same for each scenario) are shown in Figure 31.

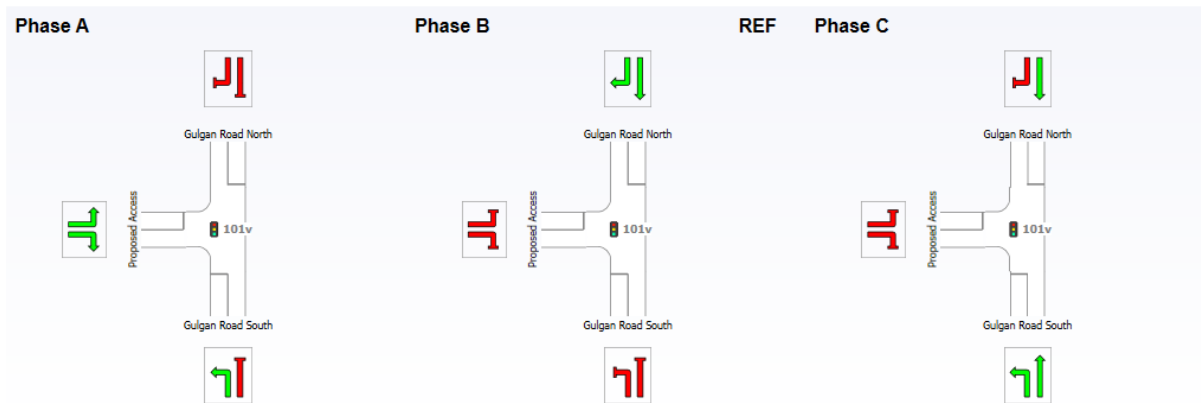

Figure 31 | Signal phasing

For the existing intersections, refer to Appendix H, where they were modelled as part of Option B, as there is no change to traffic volumes at existing intersections between Options B and C.

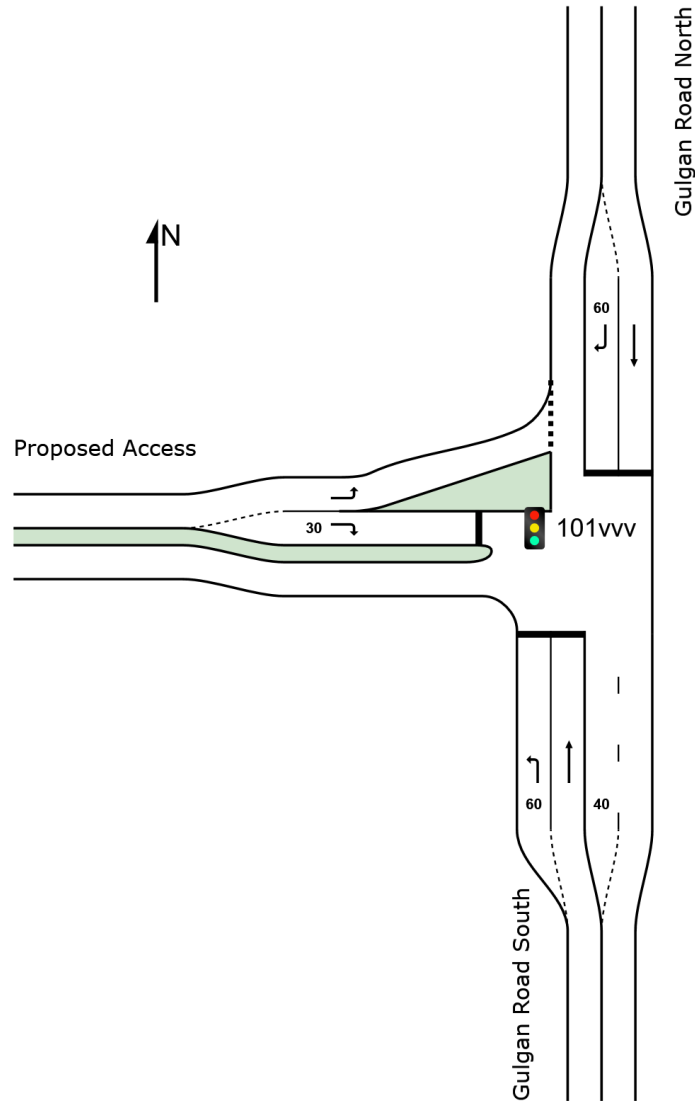

Figure 32 | Option C SIDRA layout

The Level of Service on this intersection arrangement varies significantly per lane and per time of day and is provided in Table 20. The results show that the level of service for through traffic is acceptable, and performs well for through traffic, turning traffic soon operates to LOS D, which is acceptable, but the worst allowable.

Table 20 | Option C Level of Service summary

Approach	Movement	AM Peak		PM Peak	
		2034	2044	2034	2044
Southwest	Left	B	B	B	B
	Through	C	C	B	C
BILS 5	Left	B	B	B	C
	Right	C	D	D	D

Northeast	Through	A	A	A	A
	Right	C	D	D	D

7.4. Impact on vegetation

Option C would require the removal of two trees. None of these trees are mapped as 'Biodiversity Values Mapping'.

8. OPTION D – CHANNELISED INTERSECTION

Option D is a channelised intersection specifically designed to minimise vegetation impacts.

8.1. Intersection layout

The proposed intersection layout is shown in Figure 33 below.

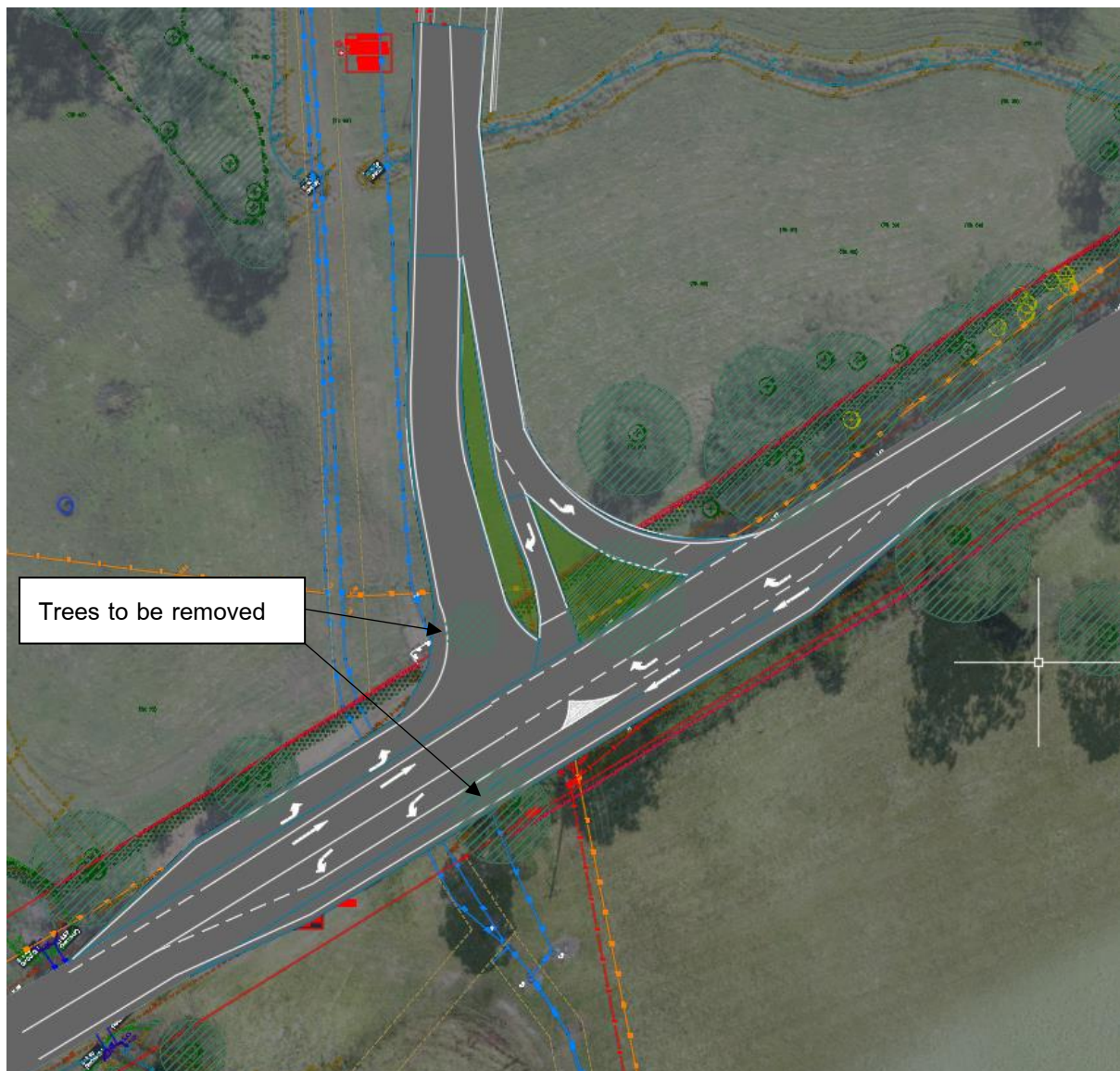

Figure 33 | Option D intersection layout

8.2. Trip distribution

The adopted trip distribution is the same as for Options B and C.

8.3. Intersection performance.

The SIDRA intersection layout is shown in Figure 34.

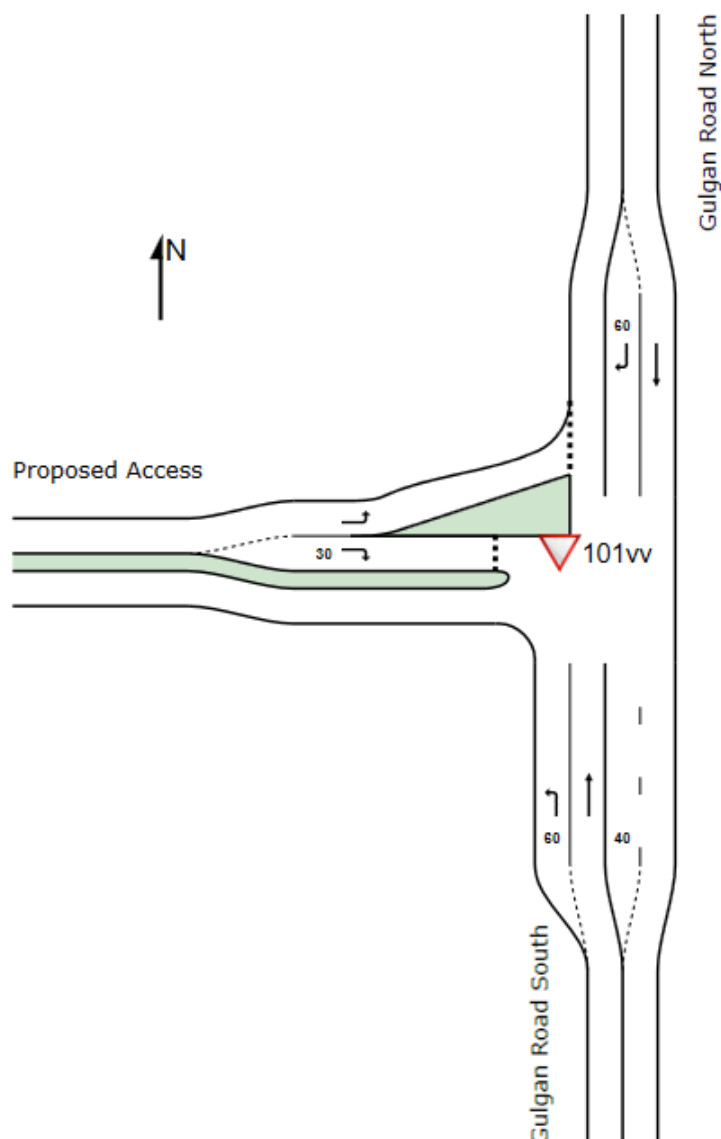

Figure 34 | Option D SIDRA layout

The intersection performs well for the Gulgan Road legs and the left turn out for all scenarios. The right turn from the site onto Gulgan Road is LOS F for all scenarios. What this means is that during peak hours, the right turn will be very slow and the vehicles needing to head south along Gulgan Road (this is the traffic to Mullumbimby only, all other traffic will head north) can use the left turn and do a U-turn at the roundabout. For the most part of the day the right turn will function adequately – it is just during peak hour traffic that the right turn becomes blocked. This can be addressed by prohibiting a right turn out during peak hours, similarly to the intersection of Ballina Road and the Bruxner Highway in Alstonville, where there is no right turn onto the highway permitted during school pick up hours.

The impact on Gulgan Road is minimal, any significant delays are contained within the subject site.

Table 21 | Option D Level of Service summary

Approach	Movement	AM Peak		PM Peak	
		2034	2044	2034	2044
Southwest	Left	A	A	A	A
	Through	A	A	A	A
BILS 5	Left	B	C	C	C
	Right	F	F	F	F
Northeast	Through	A	A	A	A
	Right	B	C	B	C

8.4. Impact on vegetation

Option D would require the removal of two trees. None of these trees are mapped as 'Biodiversity Values Mapping'.

9. INTERSECTION OPTIONS ANALYSIS

The intersection options analysis results from the previous four chapters are summarised below. It should be noted that the design horizon for options A, C and D is 10 years (2034). The 20-year horizon is included for all as Option B requires a 20-year design horizon, and therefore a clear comparison can be made. The design horizon LOS is printed in **bold** font.

It is important to note that none of these intersections result in a queue back to the motorway. The queuing distance for traffic from the north is less than the distance between this intersection and the Brunswick roundabout for all scenarios.

Table 22 | Intersection options comparison

Intersection Option	Option A (T with left in / out only)	Option B (Roundabout with bypass lane)	Option C (Signalised)	Option D (Channelised)
Worst Level of Service of BILS-5 intersection	2034: LOS A 2044: LOS B	2034: LOS B 2044: LOS C	2034: LOS D 2044: LOS D	2034: LOS B (Gulgan Road and left turn out). LOS F for right turn out. 2044: LOS C (Gulgan Road and left turn out). LOS F for right turn out.
Upgrades of existing intersections triggered	Tandys Lane	Tandys Lane	Tandys Lane	Tandys Lane
Tree removal required (all trees)	2	5	2	2
Tree removal required	1	3	0	0

(Biodiversity Value Mapping)				
Estimated construction cost ranking (1-4 is lowest to highest)	1	4	3	2
Estimated safety profile* (1-4 is worst to best)	3	4	2	1
Comments	A prerequisite is the conversion of the Mullumbimby Road intersection to a roundabout.			

**Subject to a design road safety review*

10. SENSITIVITY ANALYSES

Sensitivity analyses are carried out to assess the impact of potential fluctuations in background traffic growth due to the COVID-19 pandemic and to assess the impact of holiday peak traffic under the Hundredth Highest Hour Volume method.

10.1. Fluctuations in the background traffic growth

In order to understand the impact of fluctuating background traffic volumes, we have carried out the sensitivity analyses on existing intersections for the 2034 without development traffic scenario. The proposed access road T-junction is analysed for the 2034 including development traffic scenario.

The results are plotted in Appendix D.

The sensitivity analyses show that intersections with existing congestion issues (Mullumbimby Road and Tandy's Lane) exhibit a strong sensitivity to changes in the background traffic. At the Mullumbimby Road T-junction, a background traffic increase of some 25% results in a control delay increase of up to 4-fold.

Stark contrast to this is the performance of the proposed T-junction, where the correlation between flow scale and control delay is close to linear, not exponential.

10.2. Hundredth Highest Hour Volume

In order to assess the HHHV impact, hourly data for a full year from a permanent traffic station needs to be obtained, as this would include peak holiday conditions. Using the Transport for NSW Traffic Volume Viewer website, the nearest Permanent Classifier is found at Wardell, on the Pacific Highway, 10m north of Bridge Street, approximately 45km south of the subject site. The station key is 15190087 and the station ID is 6116. Unfortunately, there are too many data gaps (in particular around holiday periods) in this set to be reliable for this analysis.

To assist with this, TfNSW have provided SCATS data for five stations in Ballina, for the period 2016 to 2021. The five stations are shown in Figure 35. For this analysis it is assumed that the trends and holiday peaks are representative of holiday peaks (when normalised and compared to the average baseline traffic) at the subject site location. Of these stations, station 4245 provides the best datasets as it is one of the busier intersections and provides nearly error-free data for three consecutive years (2016-2018) prior to the pandemic.



Figure 35 | Ballina SCATS stations, *Source: TfNSW*

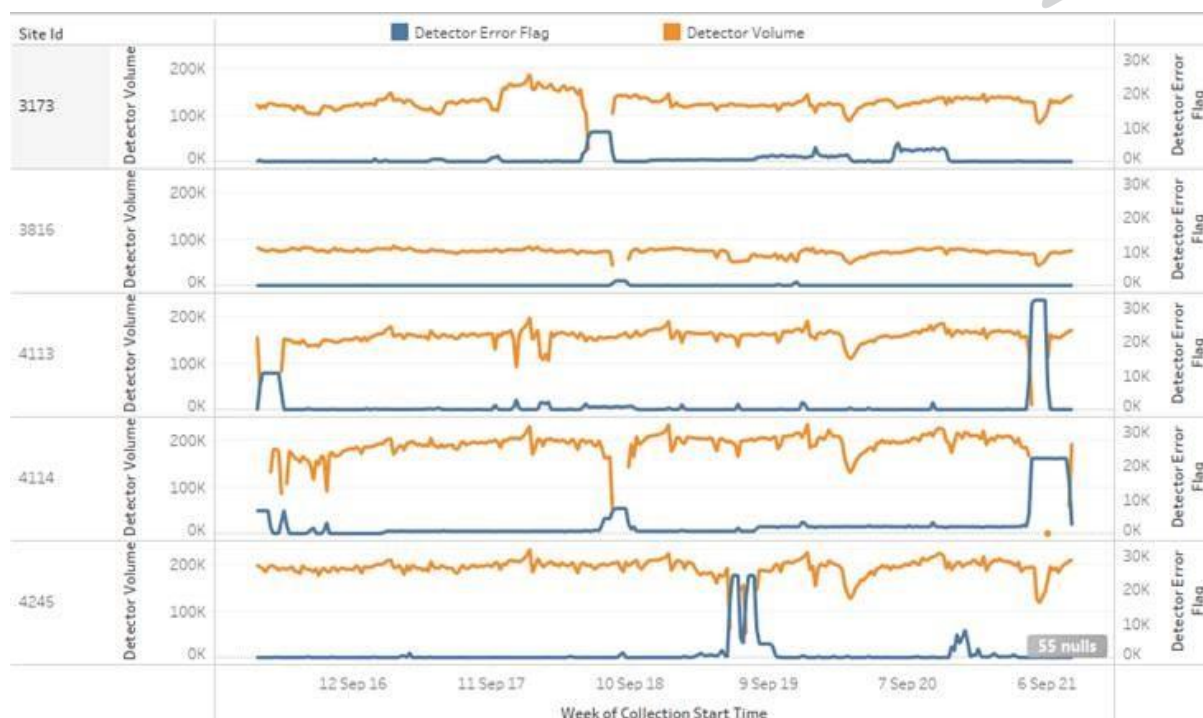

Figure 36 | Weekly SCATS counts, Source: TfNSW

The analysis results are provided in Table 23. For the years 2016, 2017 and 2018, ratios obtained by dividing the Hundredth Highest Hour Volumes (HHHV) by the average volume of that year are 2.39, 2.38 and 2.36 respectively. These rates can be applied to the average hourly volumes measured on the road network at the subject site to estimate HHHV peak traffic behaviour. It is understood that the HHHV peak hour traffic is representative of holiday peak traffic behaviour. We will adopt the HHHV factor of 2.38 for this purpose.

Table 23 | HHHV calculations

Year	2016	2017	2018
number of data points	8781	8748	8746
Days in the year	366	365	365
Hours in the year	8784	8760	8760
% complete	0.9997	0.9986	0.9984
hundredth highest hour percentile	0.9887	0.9887	0.9887
HHHV	2743	2797	2839
Average hourly volume	1146	1175	1201
HHHV factor	2.39	2.38	2.36

Using the same data set, the monthly seasonal factor can be calculated. The seasonal factor represents the average volume of that month normalised to the average volume of the entire year. This can be used to adjust the 7-day survey data that is used to carry out this analysis. The results are provided in Figure 37.

This figure shows that there are some differences in seasonality of traffic between the year, but overall a common trendline is visible of increased traffic in November/December (around 5% above average) and a lull in traffic in June. Since the Gulgan Road 7-day traffic survey was carried out at the end of July and early August, we will adopt the average seasonal factor of those months, which is 0.991. This means that the Gulgan Road traffic survey results, when averaged, are likely less than 1% different from the annual average (when no pandemic impacts are considered).

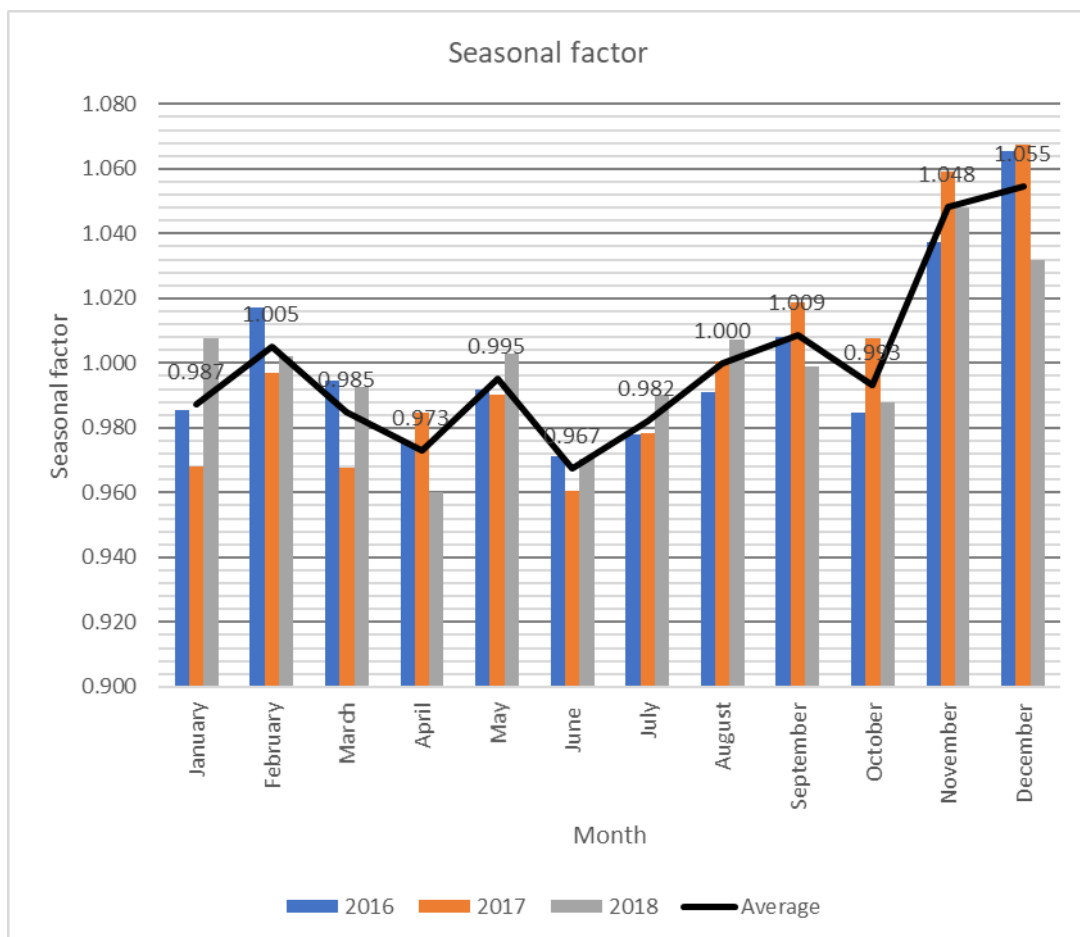

Figure 37 | Seasonal factor

The following information can be extracted from the 7-day Gulgan Road traffic survey:

- Average hourly traffic: 332
- Weekday AM peak hour traffic: 786

- Weekday AM peak hour traffic factor: 2.36
- Weekday PM peak hour traffic: 788
- Weekday PM peak hour traffic factor: 2.37

The calculated peak hour factors of 2.36 and 2.37 (for AM and PM respectively) are very close to the calculated HHHV facto values calculated above. There is therefore no further need to model HHHV traffic as the results will vary very little from the modelling already performed.

11. OTHER MODES OF TRANSPORT

11.1. Buses

The proposed main access road to the site has been designed to cater for buses. It is understood that Council will identify bus routes (NRLG DDM D1.21).

11.2. Bicycle

Byron Shire Council's Bike Plan (Figure 38) shows a high-priority cycle path on both sides of Gulgan Road at the frontage of the site. It is our understanding that this will be an on-road path, constructed within the road shoulder with no physical separation between bicycles and cars. Our roundabout design includes a pedestrian and bicycle refuge across all three legs to cater for bicycle movements.



Map legend

BIKE PLAN			Existing Path Network	
Shared Path / Cycle Path Type				
Priority				
High	Medium	Low	—	Footpath
—	—	—	—	Shared Cycle Footpath
—	—	—	—	
—	—	—	—	
—	—	—	—	
◆	◆	◆		

Figure 38 | Byron Shire Council Bike Plan

11.3. Pedestrians

It is proposed to include a footpath along one side of the main access road. This will connect with the Gulgan Road infrastructure.

The proposed development is not expect to have an impact on foot traffic on Gulgan Road as the pedestrian traffic volume on Gulgan Road is negligible. The majority of Gulgan Road has an 80 km/h posted speed limit with minimal sealed shoulders and obstructed verges, therefore currently, Gulgan Road would be unsafe for pedestrians. This is highlighted by one of the crashes recorded in section 2.5, which involved a pedestrian.

Recorded pedestrian volumes during the peak hour intersection surveys are provided below. During the surveys no pedestrian traffic was recorded at the Brunswick Roundabout. Some pedestrian traffic was recorded during the AM peak at Tandy's Lane and Mullumbimby Road, most likely associated with Uncle Tom's.

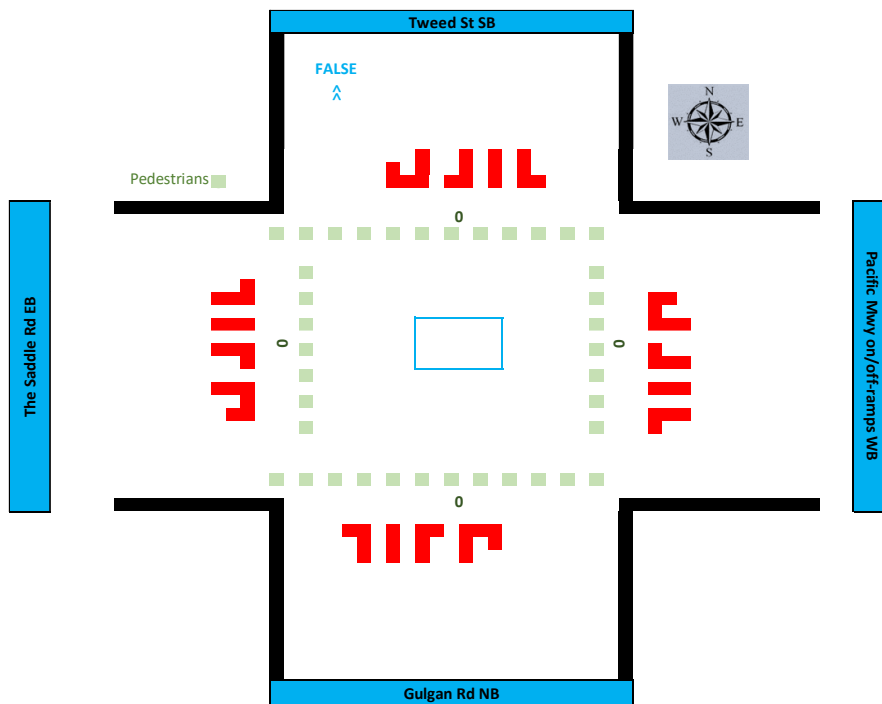

Figure 39 | Brunswick Roundabout pedestrian traffic AM peak

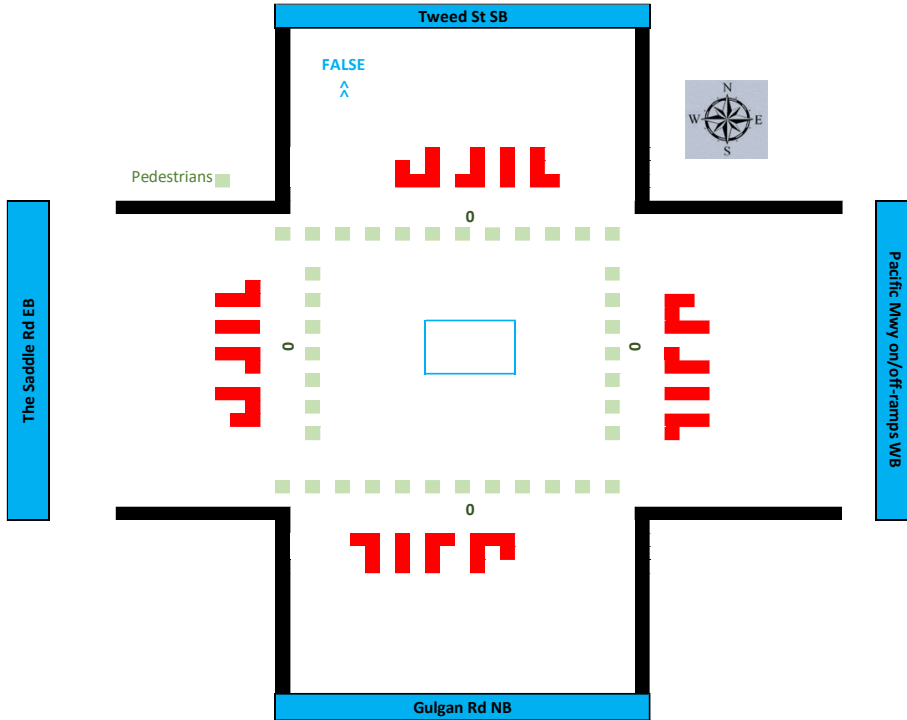

Figure 40 | Brunswick Roundabout pedestrian traffic PM peak

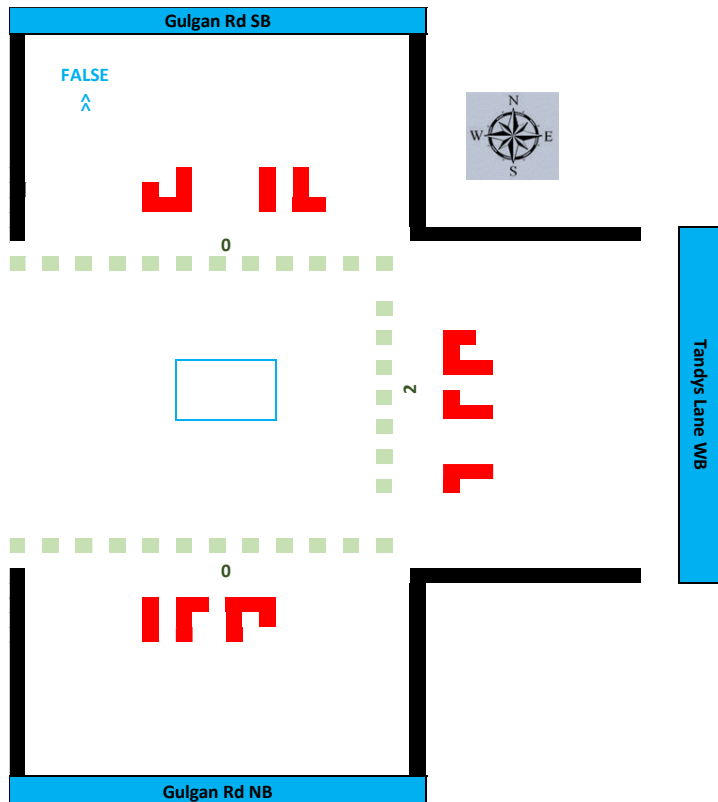

Figure 41 | Tandy's Lane intersection pedestrian traffic AM peak

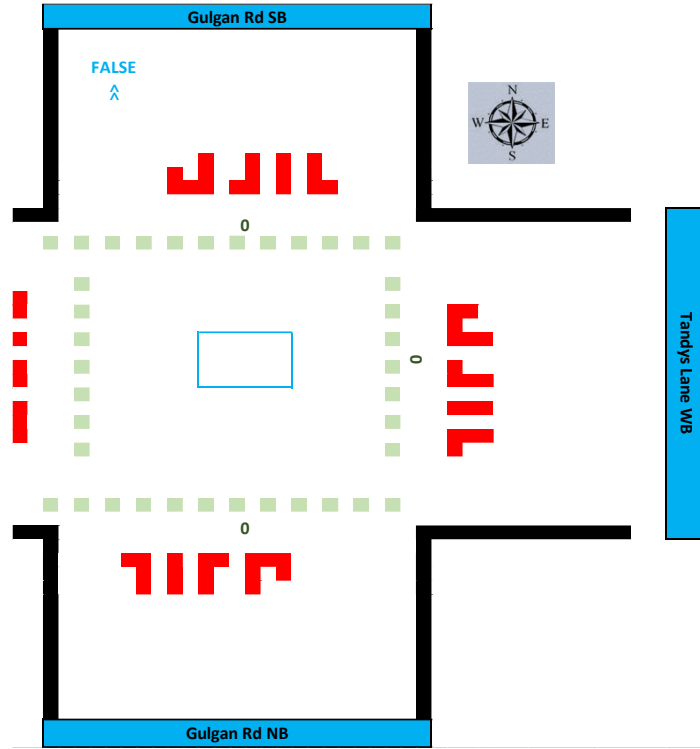

Figure 42 | Tandy's Lane intersection pedestrian traffic PM peak

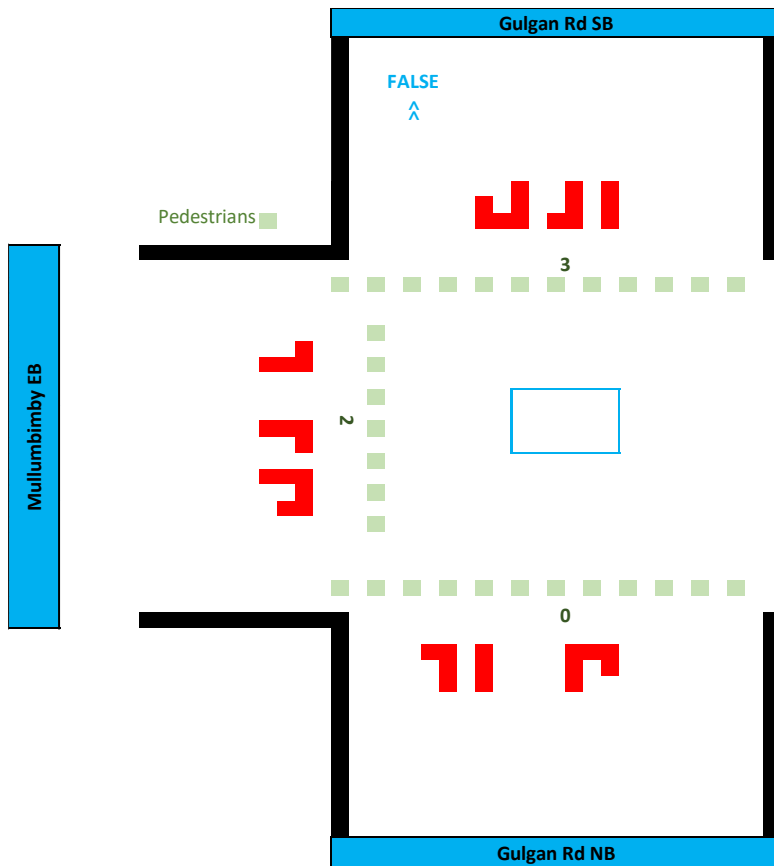

Figure 43 | Mullumbimby Road intersection pedestrian traffic AM peak

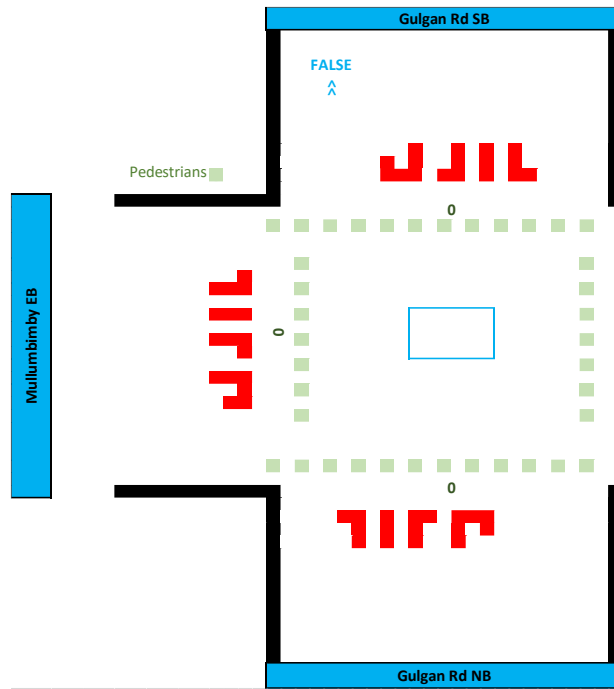

Figure 44 | Mullumbimby Road intersection pedestrian traffic PM peak

12. PARKING

12.1. Business park car parking demand

Car parking demand for the business park area is estimated using the Habitat traffic survey. The traffic survey was carried out with 5 minute intervals. That means that for every 5 minutes, the total amount of inbound and outbound vehicles was recorded. If during the 5 minute period the inbound volume exceeds the outbound, then the difference equates to the number of vehicles added to those parked on site. If outbound exceeded inbound, then the number of parked vehicles reduced.

We analysed the traffic data for parking and calibrated that using an on-site parking count on the 5th of May. Using that value (304 vehicles were parked on site in the period between 9:30 and 10:30, excluding construction-related vehicles), the spreadsheet is calibrated.

The resulting peak demands per day are depicted in Figure 45. The histogram for all 5-minute samples through the analysis period are provided in Figure 46.

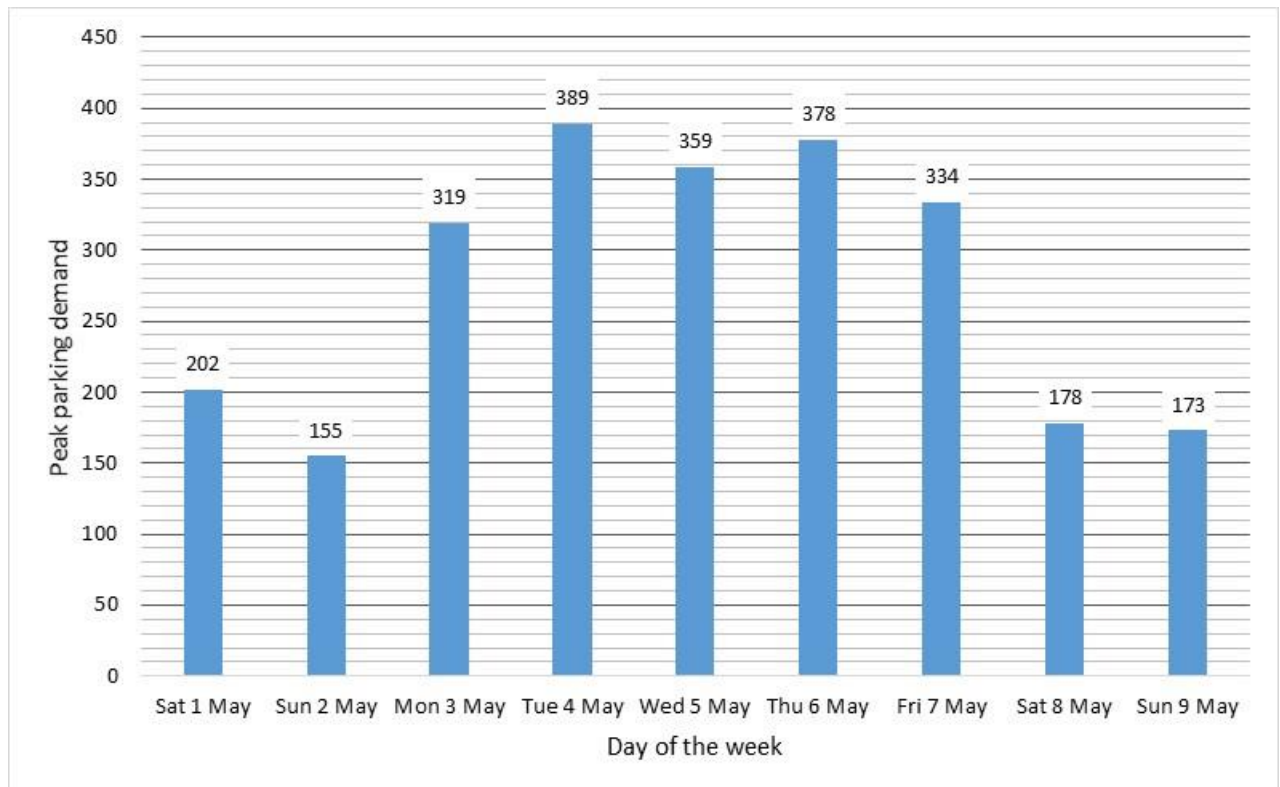

Figure 45 | Peak parking demand survey May 2021

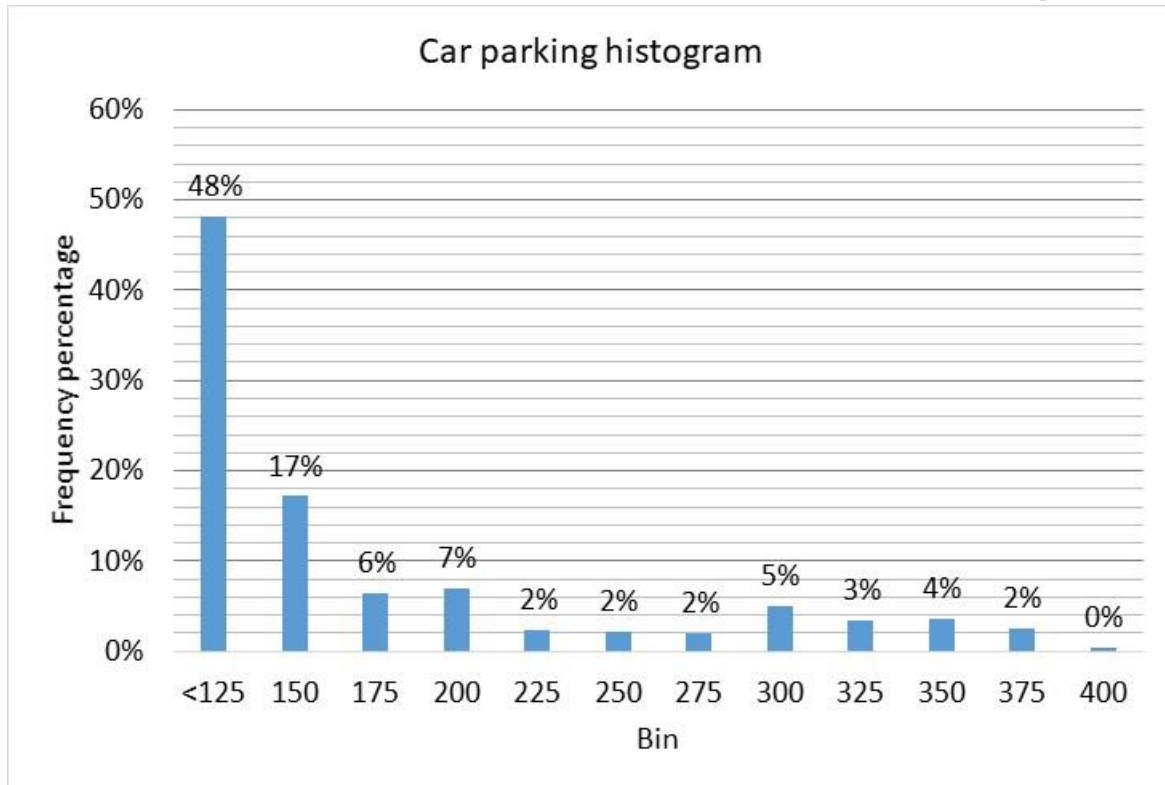

Figure 46 | Car parking survey histogram May 2021

Using the calibration point on the 5th of May, we have determined that the ‘overnight’ amount of car parking demand is 104 spaces at Habitat. That is likely representative of the residential component at Habitat.

Given that the business park precinct is relatively isolated from a transportation point of view, it is unlikely that there will be overflow parking available. We therefore recommend that sufficient car parking is provided on site to service peak demand.

The peak demand determined from our parking survey for Habitat (3.54 hectare developed) is 389 for residential and commercial combined.

Based on this we calculate the car parking demand for the business park precinct as follows, with one figure for a mixed-use zone with no residential component and one for a mixed-use zone with residential component. Adequate on-street and off-street parking should be available in the proposed business park precinct to cater for the demand calculated in Table 24.

Table 24 | Car parking calculations

Parameter	Business park, no residential	Business park with residential
Habitat 3.54 hectare developed	285	389
Peak demand per hectare	80.5	110
Business park precinct demand at 4.95 hectare	399	544

12.2. Traditional industrial car parking demand

Parking in the traditional industrial precinct can be resolved at DA stage. Each development site will need to comply with the car parking and service bay requirements of the Byron Shire DCP Chapter B4. On-street parking may be available if public roads are proposed internal to the precinct. As stated in section 3.3, no on-street parking is available on the main access road.

13. CONCLUSIONS AND RECOMMENDATIONS

We have prepared a Traffic Impact Study for the zoning concept of BILS Area 5 at Brunswick Heads. It is proposed to develop the subject site into 1.55ha of traditional industrial and 4.95ha of mixed-use zone.

The access point for all traffic will be off Gulgan Road. There is no proposal for a traffic connection with The Saddle Road.

Of the potential development traffic approximately 85% travels between the subject site and the Brunswick Heads roundabout, whilst the remaining 15% is estimated to travel south towards the Mullumbimby Road intersection.

The Mullumbimby Road intersection requires upgrading regardless of the subject development. This development does however trigger an upgrade of the Tandys Lane intersection.

Byron Shire Council have scheduled concept development and design of conversion of the Mullumbimby Road T-junction to a roundabout for 2024/2025. If that were combined with an arrangement to remove the right turn out of Tandy's Lane, then the Level of Service issues at both intersections would be resolved.

We have analysed the Hundredth Highest Hour Volume using SCATS data from a signalised intersection at Ballina. The Hundredth Highest Hour Volume is near identical to the AM and PM peak hour volumes analysed.

Adequate parking needs to be provided within the business park precinct as there are no opportunities for overflow parking elsewhere.

The four intersection options presented in this report all have different advantages and disadvantages. Through the options analysis this report shows there are several options available to create a satisfactory intersection for this site. The final design will be subject to detailed design and investigation and will seek to adhere to the current objectives.

Based on this assessment we recommend the Planning Proposal be approved from a traffic engineering perspective.

REFERENCES

New South Wales Development Design Specification D1 – Geometric Road Design (Urban and Rural), Northern Rivers Local Government AUS-SPEC, August 2013

Guide to Traffic Generating Developments, Roads and Traffic Authority, Version 2.2, October 2002

Guide to Traffic Generating Developments – Updated Traffic Surveys TDT 2013/04a, Roads and Maritime Services, August 2013

Austrroads Guide to Road Design Part 4A: Unsignalised and signalised intersections, Austrroads Inc., Sydney, June 2017

Austrroads Guide to Road Design Part 4B: Roundabouts, Austrroads Inc., Sydney, 2015

Austrroads Guide to Traffic Management Part 3: Traffic Studies and Analysis, Austrroads Inc., Sydney, November 2017

Capital-road-works-program-including-renewal-programs-for-web.xlsx,
<https://www.byron.nsw.gov.au/Services/Roads-and-parking/Managing-our-roads/Council-road-works-program>, accessed 15th November 2021

Transport for NSW Technical Note on assessing the impacts of COVID-19 for business cases, Transport for NSW, Version 1.0, June 2021

Byron Shire Business and Industrial Lands Strategy, Byron Shire Council, Mullumbimby, October 2020

<https://roadsafety.transport.nsw.gov.au/statistics/interactivecrashstats/index.html>, Transport for NSW website.

West Byron Development Transport Study, Veitch Lister Consulting Pty Ltd, V1, March 2011

Traffic Impact Assessment Proposed Rural Residential Subdivision, Ardill Payne and Partners, Ballina, November 2020

Planning Proposal – Additional Possible Employment Precinct Investigation Area – Gulgan North Precinct,
John Perkins (RMS), 7 August 2019

APPENDIX A – INTERSECTION SURVEY REPORTS

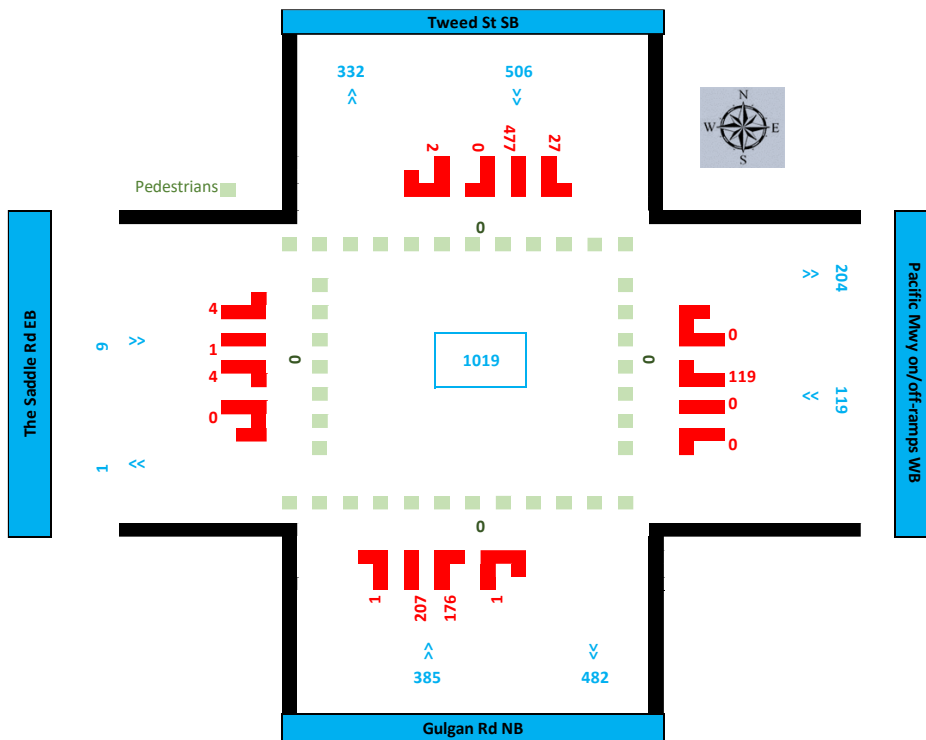

B'wick roundabout AM peak, all vehicles

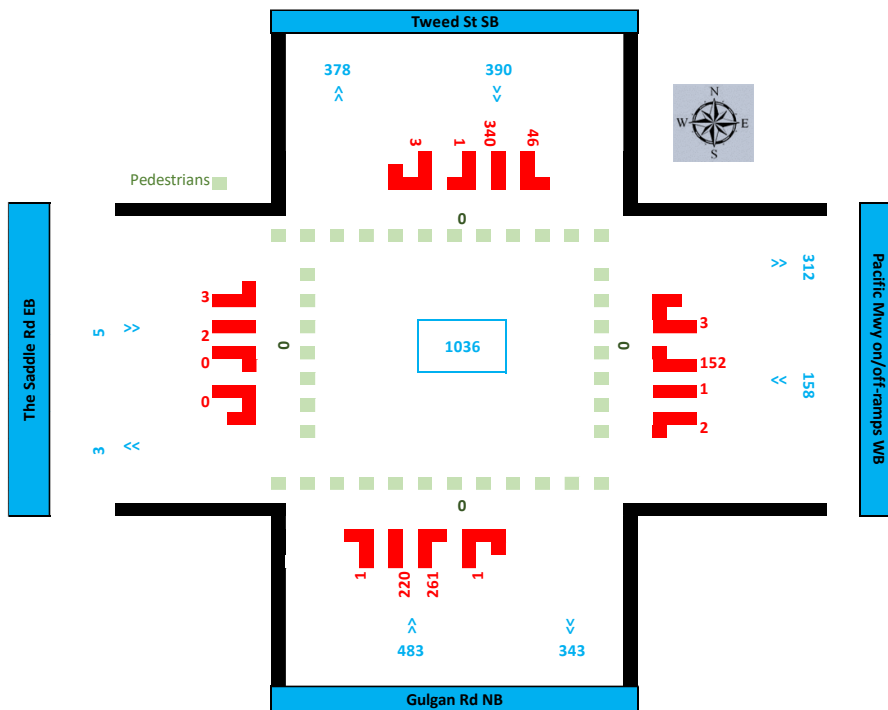

B'wick roundabout PM peak, all vehicles

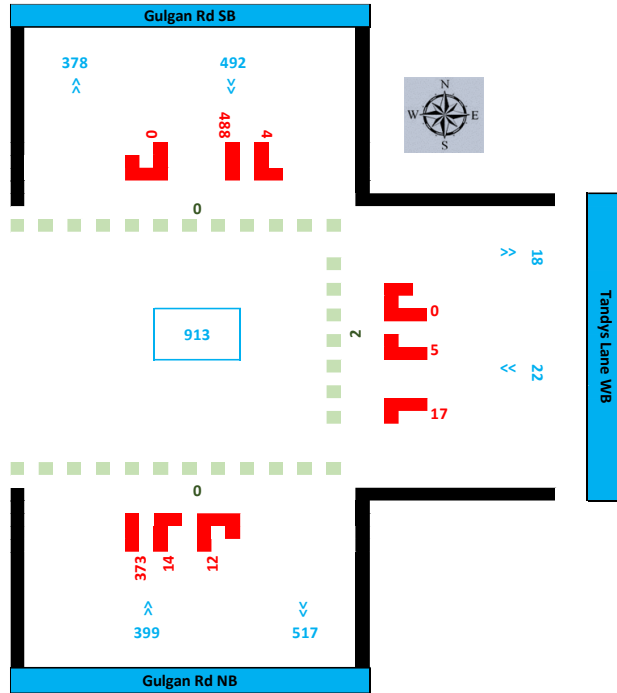

Tandy's Lane AM peak, all vehicles

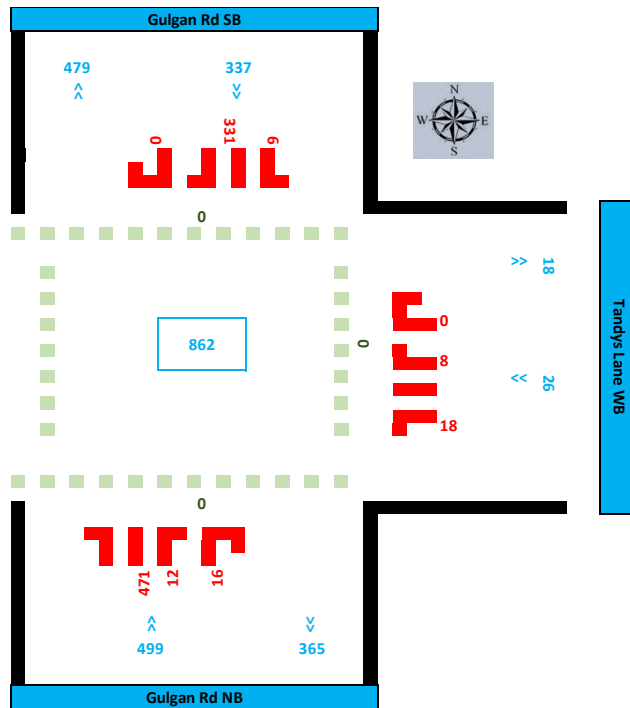

Tandy's Lane PM peak, all vehicles

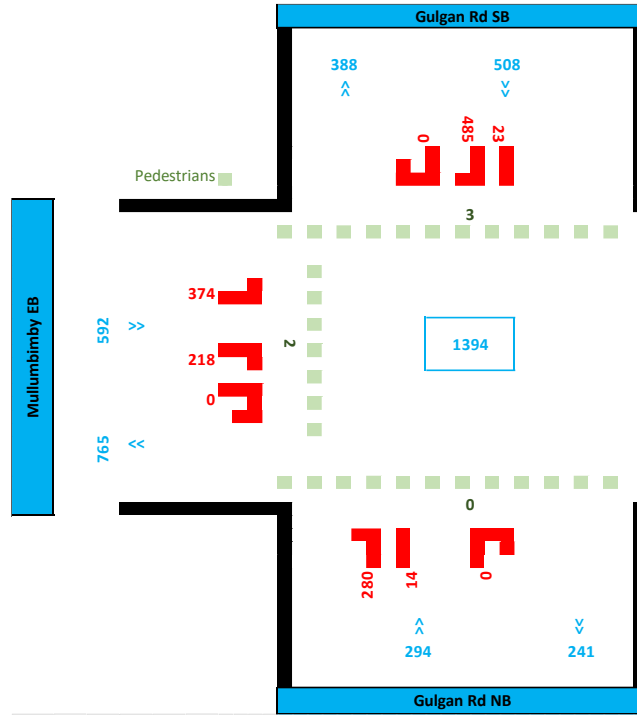

Mullumbimby Road AM peak, all vehicles

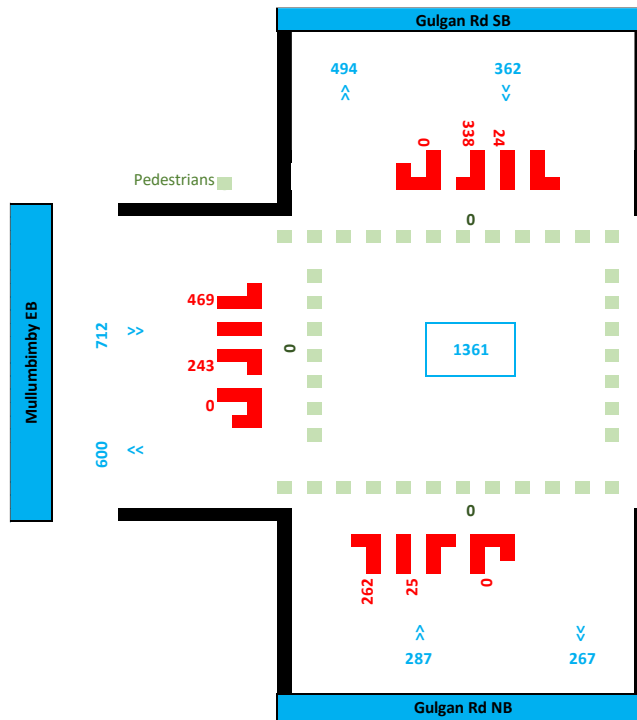

Mullumbimby Road PM peak, all vehicles

APPENDIX B – SIDRA INPUT VOLUMES

Content deleted, refer to Appendix G

APPENDIX C – SIDRA OUTPUT TABLES

Content deleted, refer to Appendix G

APPENDIX D – SENSITIVITY ANALYSIS GRAPHS

SITE GRAPHS - Demand (Flow Scale) Analysis

▽ Site: 101v [Gulgan Rd & Mullumbimby Rd (T section) - AM Peak 2034 (Site Folder: 2034)]

New Site
 Site Category: (None)
 Give-Way (Two-Way)
 Flow Scale Analysis (Upper Limit): Results for Flow Scale (chosen as largest for any movement) = 125.0 %

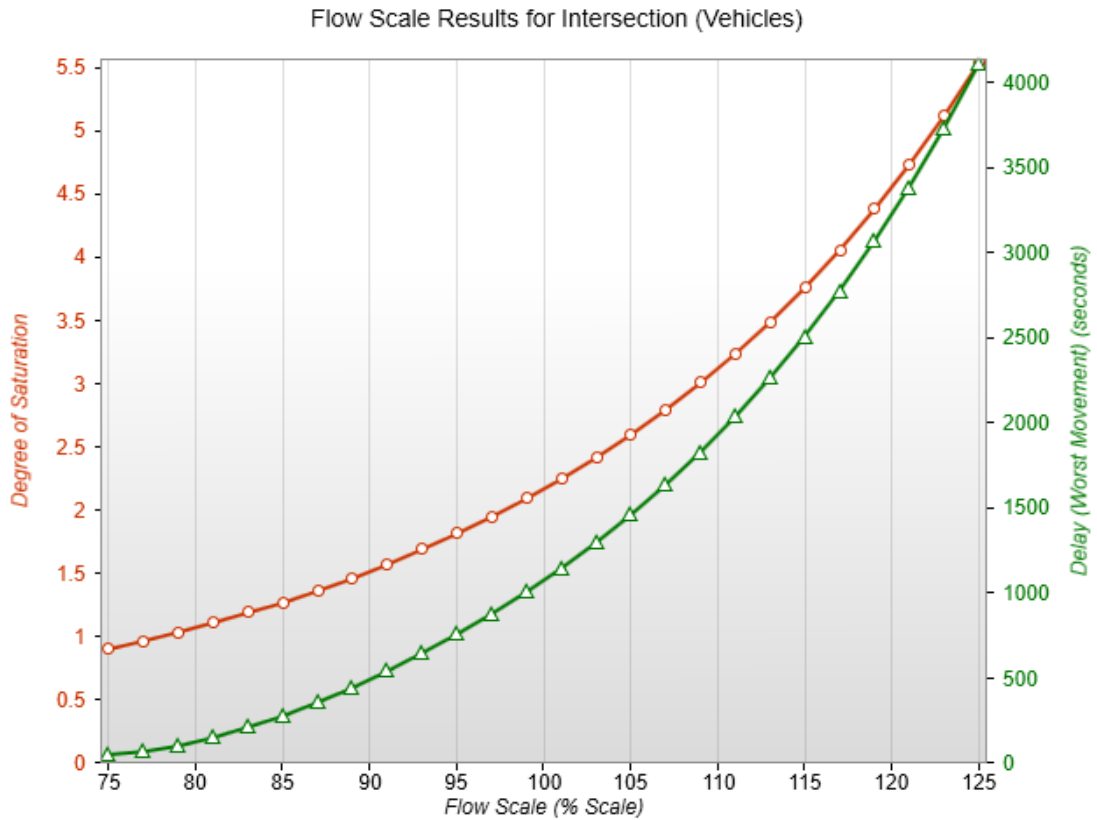

SITE GRAPHS - Demand (Flow Scale) Analysis

▽ Site: 101v [Gulgan Rd & Mullumbimby Rd (T section) - PM Peak 2031 (Site Folder: 2031)]

New Site
 Site Category: (None)
 Give-Way (Two-Way)
 Flow Scale Analysis (Upper Limit): Results for Flow Scale (chosen as largest for any movement) = 125.0 %

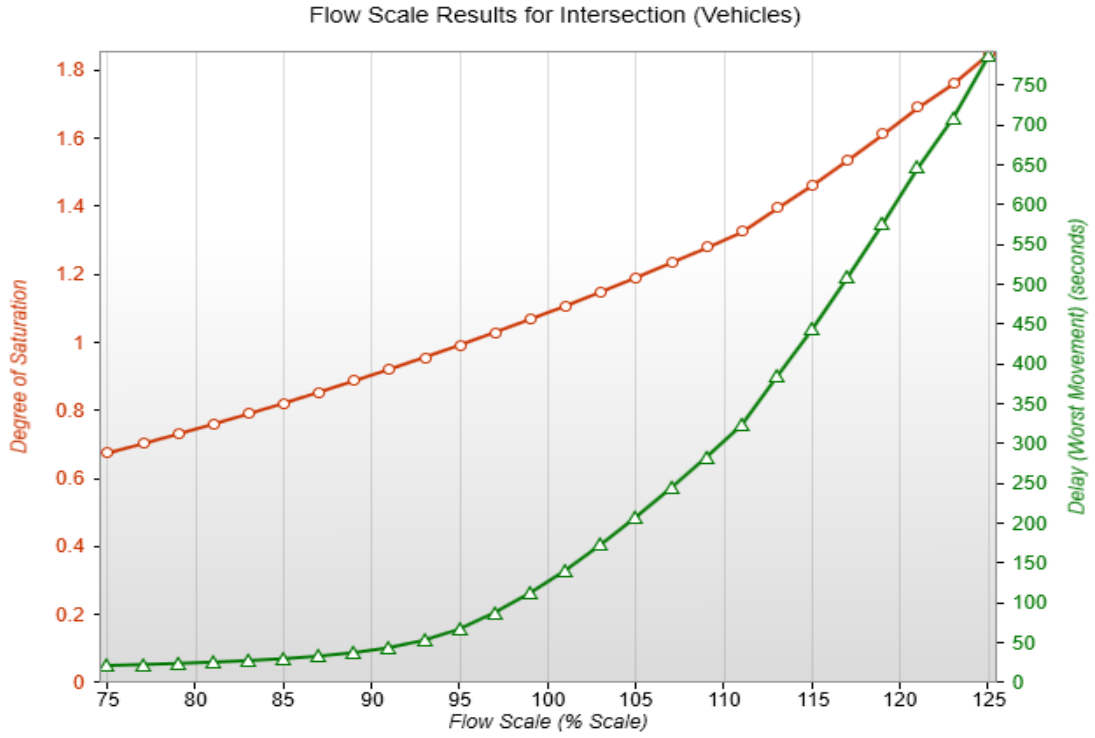

SITE GRAPHS - Demand (Flow Scale) Analysis

▽ Site: 101 [Gulgan Road T-junction AM peak 2034 (Site Folder: Scenario 3)]

New Site
Site Category: (None)
Give-Way (Two-Way)
Flow Scale Analysis (Upper Limit): Results for Flow Scale (chosen as largest for any movement) = 125.0 %

Flow Scale Results for Intersection (Vehicles)

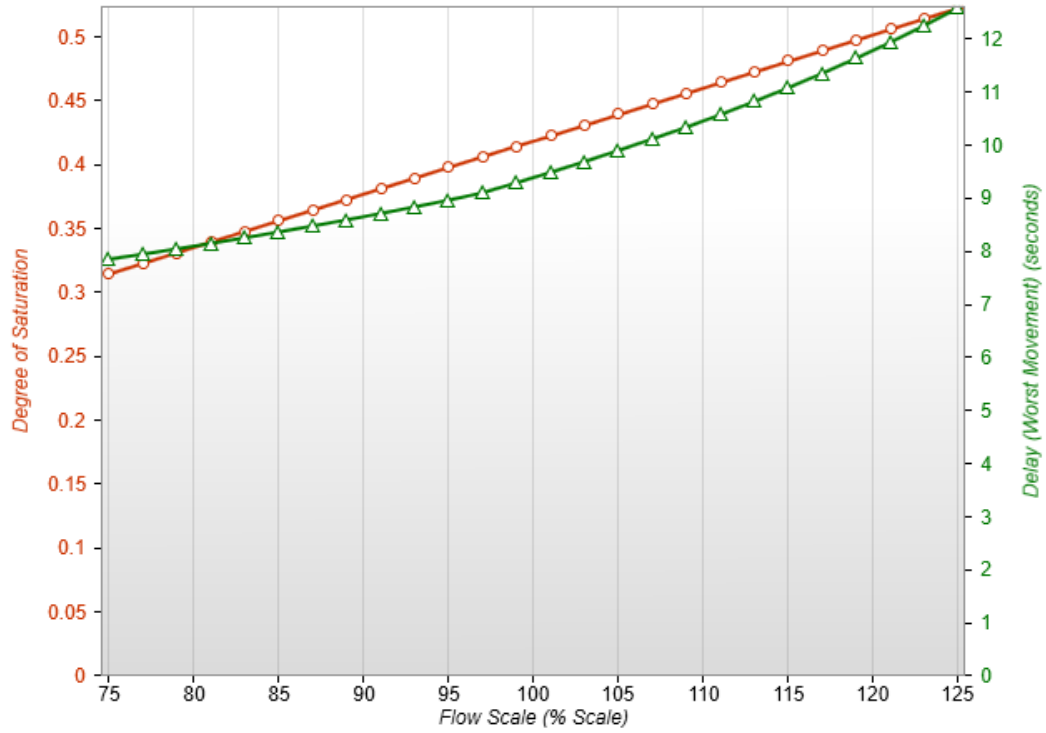

SIDRA INTERSECTION 9.0 | Copyright © 2000-2020 Akcelik and Associates Pty Ltd | sidrasolutions.com
Organisation: INGEN CONSULTING PTY LTD | Licence: PLUS / 1PC | Processed: Thursday, 17 November 2022 5:02:19 PM
Project: V:\5. Jobs\J1143_The Saddle Road, Gulgan North\4 - Modelling\SIDRA\J1143_SIDRA 171122.sip9

SITE GRAPHS - Demand (Flow Scale) Analysis

▽ Site: 102v [Gulgan Rd & Tandys Lane (T section) - PM Peak 2031 (Site Folder: 2031)]

New Site

Site Category: (None)

Give-Way (Two-Way)

Flow Scale Analysis (Upper Limit): Results for Flow Scale (chosen as largest for any movement) = 125.0 %

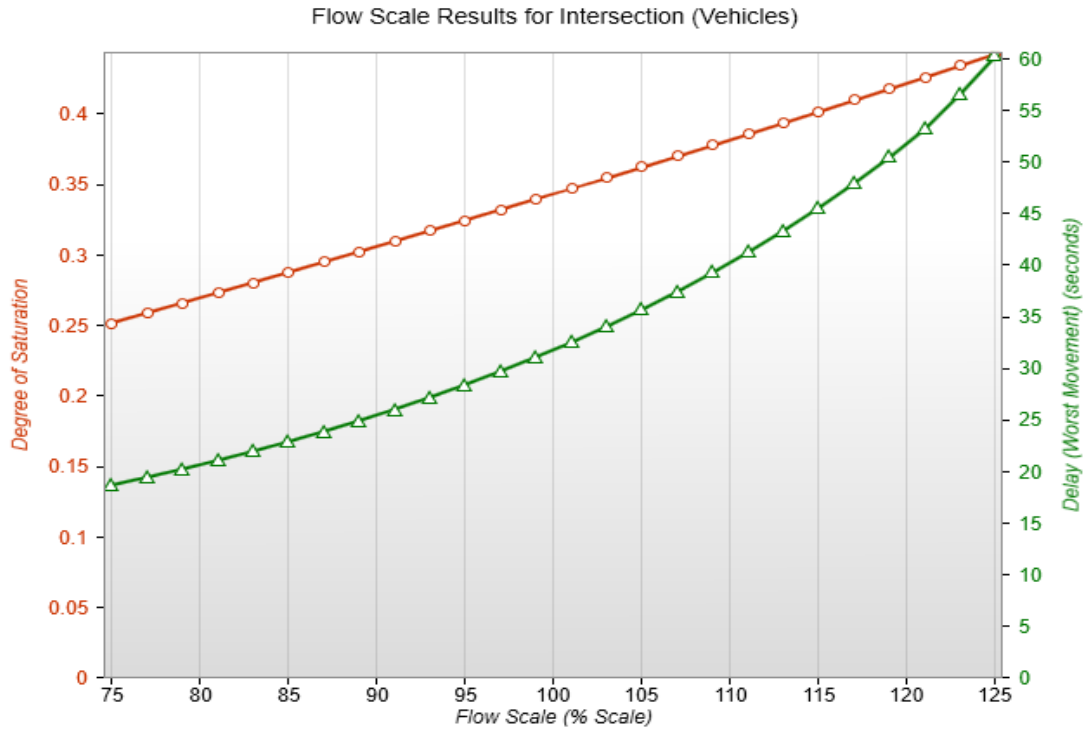

SITE GRAPHS - Demand (Flow Scale) Analysis

Site: 101 [Gulgan Rd & Saddle Rd (Roundabout) - AM Peak - 2031 (Site Folder: 2031)]

New Site

Site Category: (None)

Roundabout

Flow Scale Analysis (Upper Limit): Results for Flow Scale (chosen as largest for any movement) = 122.6 %

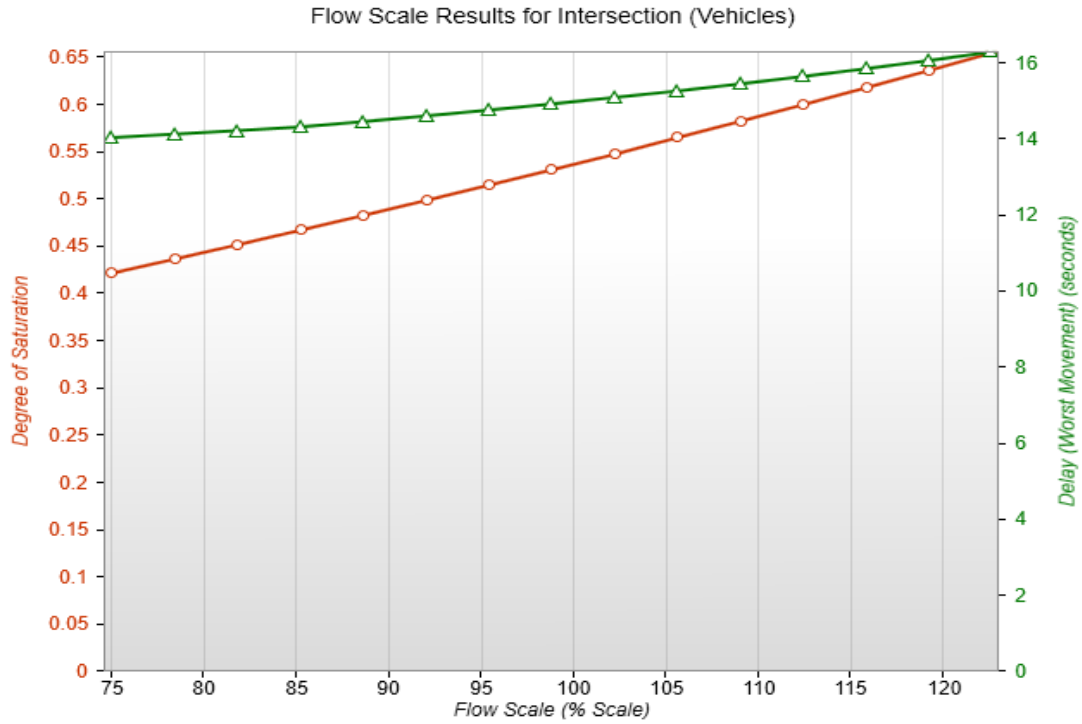

SITE GRAPHS - Demand (Flow Scale) Analysis

Site: 101 [Gulgan Rd & Saddle Rd (Roundabout) - PM Peak - 2031 (Site Folder: 2031)]

New Site

Site Category: (None)

Roundabout

Flow Scale Analysis (Upper Limit): Results for Flow Scale (chosen as largest for any movement) = 125.0 %

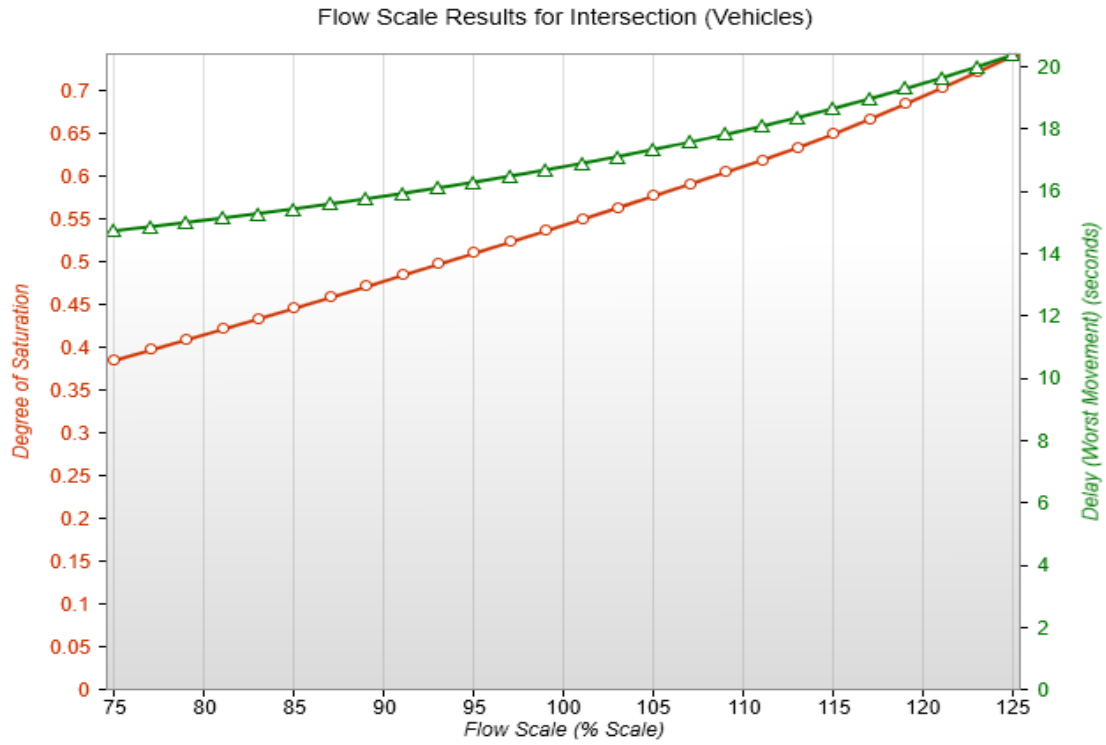

SITE GRAPHS - Demand (Flow Scale) Analysis

Site: 101 [Gulgan Road & Development Access - AM Peak - 2031 + development (Site Folder: 2031 with development)]

New Site

Site Category: (None)

Roundabout

Flow Scale Analysis (Upper Limit): Results for Flow Scale (chosen as largest for any movement) = 125.0 %

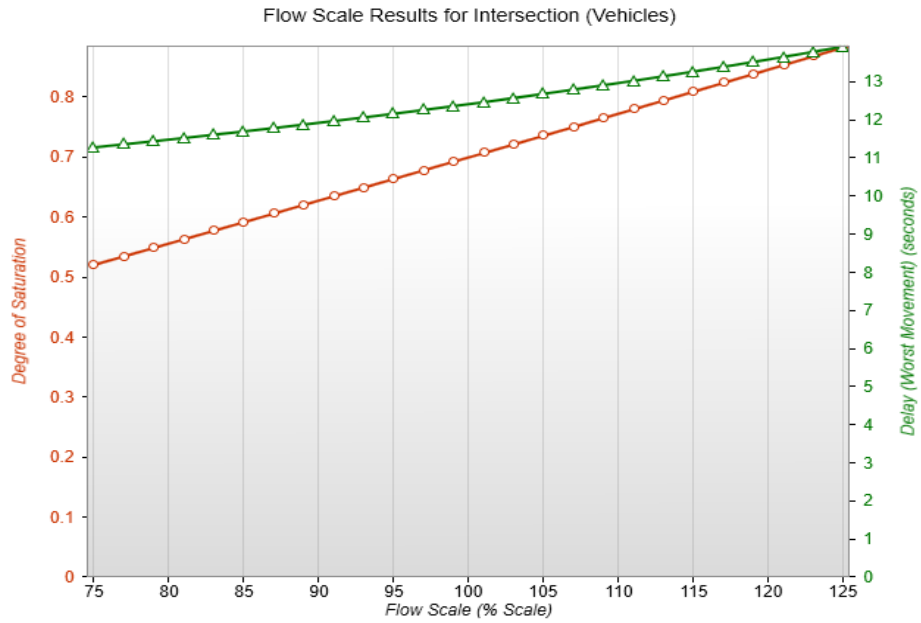

SITE GRAPHS - Demand (Flow Scale) Analysis

Site: 101 [Gulgan Road & Development Access - PM Peak - 2031 + development (Site Folder: 2031 with development)]

New Site

Site Category: (None)

Roundabout

Flow Scale Analysis (Upper Limit): Results for Flow Scale (chosen as largest for any movement) = 125.0 %

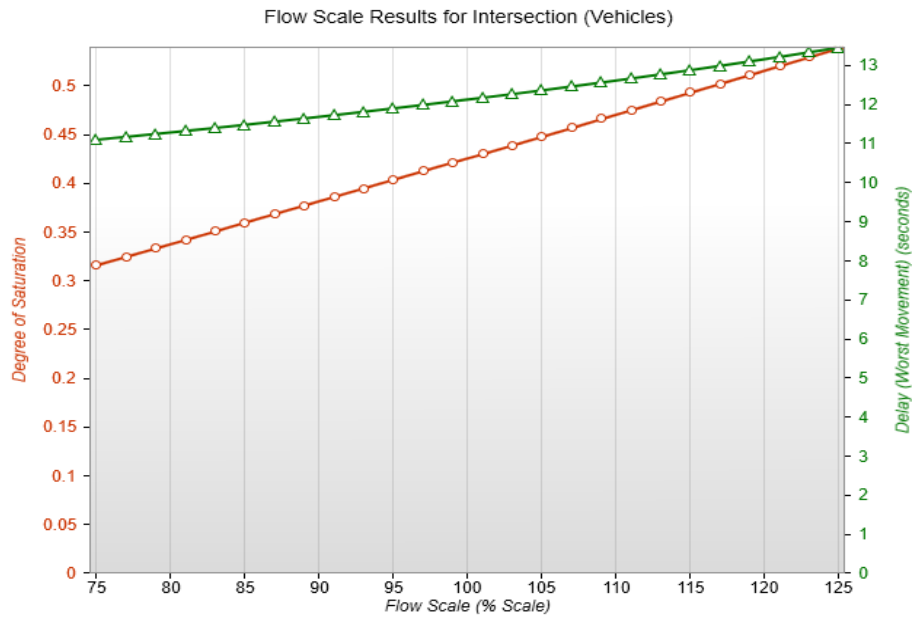

APPENDIX E – RECORD OF CONSULTATION WITH TFNSW

Michiel Kamphorst

From: Matt Adams <Matt.ADAMS@transport.nsw.gov.au>
Sent: Thursday, 18 November 2021 5:06 PM
To: Michiel Kamphorst
Subject: RE: Planning Proposal for Byron Shire Business and Industrial Lands Strategy Area 5 - Gulgan North (Brunswick Heads)

Hi Michiel

I'm making enquiries to inform a response to your enquiry below.

I was looking for other data sets that may be useful for calibration purposes and noted the Operational Noise Report 2017 for the Tintenbar to Ewingsdale Project which include tables traffic data collected between 15/08/2016 and 28/08/2016, in particular see page 43 of the report. ([Link](#))

I will be on leave next week but will aim to get back to you by the 3 Dec 2021, if not before.

Thanks

Matt Adams
Team Leader, Development Services
Community and Place | Region North
Regional & Outer Metropolitan
Transport for NSW
M 0400 474 068

From: Michiel Kamphorst [mailto:michiel@ingenconsulting.com.au]
Sent: Wednesday, 17 November 2021 3:57 PM
To: Matt Adams <Matt.ADAMS@transport.nsw.gov.au>
Subject: RE: Planning Proposal for Byron Shire Business and Industrial Lands Strategy Area 5 - Gulgan North (Brunswick Heads)

CAUTION: This email is sent from an external source. Do not click any links or open attachments unless you recognise the sender and know the content is safe.

Hi Matt,

I trust you are well.

Your colleagues at TfNSW have been extremely helpful and have provided me with 5-years worth of SCATS data from Ballina to assist with the HHH volume issue. Before I finalise my traffic report, I just want to double check with you we're on the same page.

The way I understand the Hundredth Highest Hour volume concept, is that you take the hourly traffic data for every hour of every day for an entire year (8760 data points for years with 365 days), then sort these from low to high, remove the 99 highest data points and the highest value you're left with is the HHH volume. Is that correct?

Then secondly, I understand that the purpose of the HHH volume analysis is to capture holiday peaks, is that also correct?

Thank you.

APPENDIX F – RMS LETTER TO BSC 7 AUGUST 2019

File No: NTH16/00110
Your Ref: E2019/44932

The General Manager
Byron Shire Council
PO Box 219
MULLUMBIMBY NSW 2482

Attention: Natalie Hancock
council@byron.nsw.gov.au

Dear Sir / Madam,

Planning Proposal – Additional Possible Employment Precinct Investigation Area – Gulgan North Precinct

I refer to your letter dated 24 June 2019 requesting comment from Roads and Maritime Services in relation to the abovementioned planning proposal.

Roles and Responsibilities

The key interests for Roads and Maritime Services are the safety and efficiency of the road network, traffic management, integrity of infrastructure assets and the integration of land use and transport.

The Pacific Highway (HW10) is a classified (State) road and Gulgan Road is a classified regional road (MR689). In accordance with Section 7 of the *Roads Act 1993* (the Act) Byron Shire Council is the Roads Authority for all public roads (other than Freeways and Crown roads) in the local government area. Roads and Maritime can exercise roads authority functions for classified roads in accordance with the Roads Act, and concurrence is required prior to Council's approval of works on these roads under Section 138 of the *Roads Act 1993*.

It is emphasised that the comments provided below are based on the currently exhibited Draft Employment Lands Strategy, (particularly the additional possible area at Gulgan North). They are not to be interpreted as binding upon Roads and Maritime and may change should the adopted strategy differ from that exhibited, or following formal assessment of any planning proposal referred by the relevant local planning authority.

Roads and Maritime Response

Roads and Maritime has reviewed the information provided and provides the following comments.

1. We have previously provided comment to Council during the preparation of a number of Local Growth Management Strategies and on the previously exhibited Employment Land Strategy. The comments contained in those letters, dated 6 February 2018 and 19 September 2018, remain relevant to the overall draft Strategy placed on public exhibition, although it is acknowledged that the subject Gulgan North Precinct was not included into those studies.
2. Roads and Maritime support for any release area likely to impact on the Pacific Highway interchanges will be reliant upon Council identifying the scope of infrastructure works and proposed funding sources required to support any proposed release area.

APPENDIX G – SIDRA OUTPUT OPTION A

MOVEMENT SUMMARY

▽ Site: 101 [Access Rd T 2034 AM (Site Folder: Option A)]

Output produced by SIDRA INTERSECTION Version: 9.1.1.200

New Site

Site Category: (None)

Give-Way (Two-Way)

Vehicle Movement Performance															
Mov ID	Turn	Mov Class	Demand Flows		Arrival Flows		Deg. Satn	Aver. Delay	Level of Service	95% Back Of Queue		Prop. Que	Eff. Stop Rate	Aver. No. of Cycles	Aver. Speed
			[Total veh/h]	[HV %]	[Total veh/h]	[HV %]				[Veh. veh]	[Dist m]				
South: Gulgan Road (S)															
1	L2	All MCs	274	10.4	274	10.4	0.158	5.8	LOS A	0.0	0.0	0.00	0.52	0.00	50.0
2	T1	All MCs	783	7.1	783	7.1	0.420	1.2	LOS A	0.0	0.0	0.00	0.20	0.00	58.2
Approach			1057	8.0	1057	8.0	0.420	2.4	NA	0.0	0.0	0.00	0.28	0.00	56.0
North: Gulgan Road (N)															
8	T1	All MCs	778	2.4	778	2.4	0.405	1.1	LOS A	0.0	0.0	0.00	0.20	0.00	58.2
Approach			778	2.4	778	2.4	0.405	1.1	NA	0.0	0.0	0.00	0.20	0.00	58.2
West: Access Road															
10	L2	All MCs	158	10.7	158	10.7	0.091	8.3	LOS A	0.0	0.0	0.00	0.52	0.00	46.3
Approach			158	10.7	158	10.7	0.091	8.3	NA	0.0	0.0	0.00	0.52	0.00	46.3
All Vehicles			1993	6.0	1993	6.0	0.420	2.4	NA	0.0	0.0	0.00	0.27	0.00	56.2

MOVEMENT SUMMARY

▽ Site: 101 [Access Rd T 2034 PM (Site Folder: Option A)]

Output produced by SIDRA INTERSECTION Version: 9.1.1.200

New Site

Site Category: (None)

Give-Way (Two-Way)

Vehicle Movement Performance															
Mov ID	Turn	Mov Class	Demand Flows		Arrival Flows		Deg. Satn	Aver. Delay	Level of Service	95% Back Of Queue		Prop. Que	Eff. Stop Rate	Aver. No. of Cycles	Aver. Speed
			[Total veh/h]	[HV %]	[Total veh/h]	[HV %]				[Veh. veh]	[Dist m]				
South: Gulgan Road (S)															
1	L2	All MCs	182	10.4	182	10.4	0.105	5.7	LOS A	0.0	0.0	0.00	0.52	0.00	50.0
2	T1	All MCs	1072	2.8	1072	2.8	0.559	1.3	LOS A	0.0	0.0	0.00	0.19	0.00	58.0
Approach			1254	3.9	1254	3.9	0.559	1.9	NA	0.0	0.0	0.00	0.24	0.00	56.8
North: Gulgan Road (N)															
8	T1	All MCs	551	2.3	551	2.3	0.287	1.1	LOS A	0.0	0.0	0.00	0.20	0.00	58.3

Approach	551	2.3	551	2.3	0.287	1.1	NA	0.0	0.0	0.00	0.20	0.00	58.3
West: Access Road													
10 L2 All MCs	237	10.7	237	10.7	0.137	11.8	LOS A	0.0	0.0	0.00	0.52	0.00	46.3
Approach	237	10.7	237	10.7	0.137	11.8	NA	0.0	0.0	0.00	0.52	0.00	46.3
All Vehicles	2041	4.2	2041	4.2	0.559	2.9	NA	0.0	0.0	0.00	0.26	0.00	56.2

MOVEMENT SUMMARY

Site: 101 [Access Rd T 2044 AM (Site Folder: Option A)]

Output produced by SIDRA INTERSECTION Version: 9.1.1.200

New Site
Site Category: (None)
Give-Way (Two-Way)

Vehicle Movement Performance

Mov ID	Turn	Mov Class	Demand Flows		Arrival Flows		Deg. Satn	Aver. Delay	Level of Service	95% Back Of Queue		Prop. Que	Eff. Stop Rate	Aver. No. of Cycles	Aver. Speed
			[Total veh/h]	[HV %]	[Total veh/h]	[HV %]				[Veh. veh]	[Dist. m]				
South: Gulgan Road (S)															
1	L2	All MCs	274	10.4	274	10.4	0.158	5.8	LOS A	0.0	0.0	0.00	0.52	0.00	50.0
2	T1	All MCs	1025	6.9	1025	6.9	0.549	1.3	LOS A	0.0	0.0	0.00	0.19	0.00	58.0
Approach			1299	7.6	1299	7.6	0.549	2.2	NA	0.0	0.0	0.00	0.26	0.00	56.3
North: Gulgan Road (N)															
8	T1	All MCs	1083	2.5	1083	2.5	0.565	1.2	LOS A	0.0	0.0	0.00	0.19	0.00	58.0
Approach			1083	2.5	1083	2.5	0.565	1.2	NA	0.0	0.0	0.00	0.19	0.00	58.0
West: Access Road															
10	L2	All MCs	158	10.7	158	10.7	0.091	10.6	LOS A	0.0	0.0	0.00	0.52	0.00	46.3
Approach			158	10.7	158	10.7	0.091	10.6	NA	0.0	0.0	0.00	0.52	0.00	46.3
All Vehicles			2540	5.6	2540	5.6	0.565	2.3	NA	0.0	0.0	0.00	0.25	0.00	56.5

MOVEMENT SUMMARY

Site: 101 [Access Rd T 2044 PM (Site Folder: Option A)]

Output produced by SIDRA INTERSECTION Version: 9.1.1.200

New Site
Site Category: (None)
Give-Way (Two-Way)

Vehicle Movement Performance

Mov ID	Turn	Mov Class	Demand Flows		Arrival Flows		Deg. Satn	Aver. Delay	Level of Service	95% Back Of Queue		Prop. Que	Eff. Stop Rate	Aver. No. of Cycles	Aver. Speed
			[Total veh/h]	[HV %]	[Total veh/h]	[HV %]				[Veh. veh]	[Dist. m]				
South: Gulgan Road (S)															
1	L2	All MCs	182	10.4	182	10.4	0.105	5.7	LOS A	0.0	0.0	0.00	0.52	0.00	50.0

2	T1	All MCs	1377	2.7	1377	2.7	0.718	1.5	LOS A	0.0	0.0	0.00	0.18	0.00	57.6
Approach			1559	3.6	1559	3.6	0.718	2.0	NA	0.0	0.0	0.00	0.22	0.00	56.7
North: Gulgan Road (N)															
8	T1	All MCs	771	2.9	771	2.9	0.403	1.1	LOS A	0.0	0.0	0.00	0.20	0.00	58.2
Approach			771	2.9	771	2.9	0.403	1.1	NA	0.0	0.0	0.00	0.20	0.00	58.2
West: Access Road															
10	L2	All MCs	237	10.7	237	10.7	0.137	26.8	LOS B	0.0	0.0	0.00	0.52	0.00	46.3
Approach			237	10.7	237	10.7	0.137	26.8	NA	0.0	0.0	0.00	0.52	0.00	46.3
All Vehicles			2566	4.0	2566	4.0	0.718	4.0	NA	0.0	0.0	0.00	0.24	0.00	56.4

MOVEMENT SUMMARY

 Site: 101 [Bruns Rbout 2024 AM background (Site Folder: Option A)]

Output produced by SIDRA INTERSECTION Version: 9.1.1.200

New Site
Site Category: (None)
Roundabout

Vehicle Movement Performance

Mov ID	Turn	Mov Class	Demand Flows		Arrival Flows		Deg. Satn	Aver. Delay	Level of Service	95% Back Of Queue		Prop. Que	Eff. Stop Rate	Aver. No. of Cycles	Aver. Speed
			[Total veh/h]	[HV %]	[Total veh/h]	[HV %]				[Veh. veh]	[Dist. m]				
South: Gulgan Road															
1	L2	All MCs	1	100.0	1	100.0	0.319	5.6	LOS A	2.3	16.9	0.41	0.50	0.41	49.9
2	T1	All MCs	229	4.4	229	4.4	0.319	4.0	LOS A	2.3	16.9	0.41	0.50	0.41	52.7
3	R2	All MCs	191	6.3	191	6.3	0.319	10.1	LOS B	2.3	16.9	0.41	0.50	0.41	51.7
3u	U	All MCs	1	0.0	1	0.0	0.319	12.4	LOS B	2.3	16.9	0.41	0.50	0.41	51.9
Approach			422	5.5	422	5.5	0.319	6.8	LOS A	2.3	16.9	0.41	0.50	0.41	52.2
East: Pacific Mwy															
4	L2	All MCs	1	0.0	1	0.0	0.136	5.8	LOS A	0.9	6.2	0.65	0.68	0.65	49.6
5	T1	All MCs	1	0.0	1	0.0	0.136	5.7	LOS A	0.9	6.2	0.65	0.68	0.65	49.9
6	R2	All MCs	131	3.1	131	3.1	0.136	11.9	LOS B	0.9	6.2	0.65	0.68	0.65	49.0
6u	U	All MCs	1	0.0	1	0.0	0.136	14.2	LOS B	0.9	6.2	0.65	0.68	0.65	49.1
Approach			134	3.0	134	3.0	0.136	11.8	LOS B	0.9	6.2	0.65	0.68	0.65	49.0
North: Tweed Street															
7	L2	All MCs	30	0.0	30	0.0	0.445	4.6	LOS A	3.4	24.3	0.52	0.46	0.52	53.3
8	T1	All MCs	527	2.1	527	2.1	0.445	4.6	LOS A	3.4	24.3	0.52	0.46	0.52	53.7
9	R2	All MCs	1	0.0	1	0.0	0.445	10.6	LOS B	3.4	24.3	0.52	0.46	0.52	52.7
9u	U	All MCs	2	0.0	2	0.0	0.445	13.0	LOS B	3.4	24.3	0.52	0.46	0.52	52.7
Approach			560	2.0	560	2.0	0.445	4.6	LOS A	3.4	24.3	0.52	0.46	0.52	53.6
West: Saddle Road															
10	L2	All MCs	4	0.0	4	0.0	0.011	2.4	LOS A	0.1	0.5	0.61	0.38	0.61	10.5
11	T1	All MCs	1	0.0	1	0.0	0.011	2.4	LOS A	0.1	0.5	0.61	0.38	0.61	10.5
12	R2	All MCs	4	50.0	4	50.0	0.011	3.5	LOS A	0.1	0.5	0.61	0.38	0.61	10.5

12u	U	All MCs	1	0.0	1	0.0	0.011	14.0	LOS B	0.1	0.5	0.61	0.38	0.61	17.8
Approach			10	20.0	10	20.0	0.011	4.0	LOS A	0.1	0.5	0.61	0.38	0.61	10.9
All Vehicles			1126	3.6	1126	3.6	0.445	6.3	LOS A	3.4	24.3	0.50	0.50	0.50	50.8

MOVEMENT SUMMARY

 Site: 101 [Bruns Rbout 2034 AM background (Site Folder: Option A)]

Output produced by SIDRA INTERSECTION Version: 9.1.1.200

New Site
Site Category: (None)
Roundabout

Vehicle Movement Performance

Mov ID	Turn	Mov Class	Demand Flows		Arrival Flows		Deg. Satn	Aver. Delay	Level of Service	95% Back Of Queue		Prop. Que	Eff. Stop Rate	Aver. No. of Cycles	Aver. Speed
			[Total]	[HV]	[Total]	[HV]				[Veh.]	[Dist]				
			veh/h	%	veh/h	%	v/c	sec		veh	m				km/h
South: Gulgan Road															
1	L2	All MCs	1	100.0	1	100.0	0.476	6.7	LOS A	4.1	30.4	0.57	0.54	0.57	49.4
2	T1	All MCs	318	4.4	318	4.4	0.476	4.5	LOS A	4.1	30.4	0.57	0.54	0.57	52.1
3	R2	All MCs	270	7.8	270	7.8	0.476	10.6	LOS B	4.1	30.4	0.57	0.54	0.57	51.0
3u	U	All MCs	2	0.0	2	0.0	0.476	12.9	LOS B	4.1	30.4	0.57	0.54	0.57	51.3
Approach			591	6.1	591	6.1	0.476	7.3	LOS A	4.1	30.4	0.57	0.54	0.57	51.6
East: Pacific Mwy															
4	L2	All MCs	1	0.0	1	0.0	0.248	7.6	LOS A	1.9	13.6	0.86	0.74	0.86	48.8
5	T1	All MCs	1	0.0	1	0.0	0.248	7.5	LOS A	1.9	13.6	0.86	0.74	0.86	49.1
6	R2	All MCs	182	3.3	182	3.3	0.248	13.7	LOS B	1.9	13.6	0.86	0.74	0.86	48.2
6u	U	All MCs	1	0.0	1	0.0	0.248	16.0	LOS B	1.9	13.6	0.86	0.74	0.86	48.3
Approach			185	3.2	185	3.2	0.248	13.7	LOS B	1.9	13.6	0.86	0.74	0.86	48.2
North: Tweed Street															
7	L2	All MCs	41	0.0	41	0.0	0.673	6.7	LOS A	7.6	54.0	0.79	0.63	0.86	52.1
8	T1	All MCs	732	2.0	732	2.0	0.673	6.7	LOS A	7.6	54.0	0.79	0.63	0.86	52.4
9	R2	All MCs	1	0.0	1	0.0	0.673	12.6	LOS B	7.6	54.0	0.79	0.63	0.86	51.5
9u	U	All MCs	3	0.0	3	0.0	0.673	15.0	LOS B	7.6	54.0	0.79	0.63	0.86	51.5
Approach			777	1.9	777	1.9	0.673	6.7	LOS A	7.6	54.0	0.79	0.63	0.86	52.4
West: Saddle Road															
10	L2	All MCs	6	0.0	6	0.0	0.022	4.1	LOS A	0.1	1.1	0.75	0.52	0.75	10.2
11	T1	All MCs	2	0.0	2	0.0	0.022	4.1	LOS A	0.1	1.1	0.75	0.52	0.75	10.2
12	R2	All MCs	6	50.0	6	50.0	0.022	5.7	LOS A	0.1	1.1	0.75	0.52	0.75	10.2
12u	U	All MCs	1	0.0	1	0.0	0.022	15.7	LOS B	0.1	1.1	0.75	0.52	0.75	17.1
Approach			15	20.0	15	20.0	0.022	5.5	LOS A	0.1	1.1	0.75	0.52	0.75	10.5
All Vehicles			1568	3.8	1568	3.8	0.673	7.8	LOS A	7.6	54.0	0.71	0.61	0.75	49.7

MOVEMENT SUMMARY

Site: 101 [Bruns Rbout 2034 AM development (Site Folder: Option A)]

Output produced by SIDRA INTERSECTION Version: 9.1.1.200

New Site
Site Category: (None)
Roundabout

Vehicle Movement Performance															
Mov ID	Turn	Mov Class	Demand Flows		Arrival Flows		Deg. Satn	Aver. Delay	Level of Service	95% Back Of Queue		Prop. Que	Eff. Stop Rate	Aver. No. of Cycles	Aver. Speed
			[Total	HV]	[Total	HV]				[Veh.	Dist]				
			veh/h	%	veh/h	%	v/c	sec		veh	m				km/h
South: Gulgan Road															
1	L2	All MCs	2	100.0	2	100.0	0.616	7.2	LOS A	6.5	48.3	0.69	0.55	0.69	49.0
2	T1	All MCs	427	5.9	427	5.9	0.616	4.8	LOS A	6.5	48.3	0.69	0.55	0.69	51.7
3	R2	All MCs	305	8.2	305	8.2	0.616	10.9	LOS B	6.5	48.3	0.69	0.55	0.69	50.6
3u	U	All MCs	29	10.3	29	10.3	0.616	13.4	LOS B	6.5	48.3	0.69	0.55	0.69	50.6
Approach			763	7.2	763	7.2	0.616	7.6	LOS A	6.5	48.3	0.69	0.55	0.69	51.2
East: Pacific Mwy															
4	L2	All MCs	1	0.0	1	0.0	0.336	9.7	LOS A	2.8	20.4	1.00	0.78	1.00	47.6
5	T1	All MCs	1	0.0	1	0.0	0.336	9.6	LOS A	2.8	20.4	1.00	0.78	1.00	47.8
6	R2	All MCs	182	3.3	182	3.3	0.336	15.8	LOS B	2.8	20.4	1.00	0.78	1.00	47.0
6u	U	All MCs	1	0.0	1	0.0	0.336	18.0	LOS B	2.8	20.4	1.00	0.78	1.00	47.1
Approach			185	3.2	185	3.2	0.336	15.8	LOS B	2.8	20.4	1.00	0.78	1.00	47.0
North: Tweed Street															
7	L2	All MCs	41	0.0	41	0.0	0.846	12.8	LOS B	16.4	118.0	1.00	0.96	1.42	49.0
8	T1	All MCs	858	3.4	858	3.4	0.846	12.9	LOS B	16.4	118.0	1.00	0.96	1.42	49.2
9	R2	All MCs	1	0.0	1	0.0	0.846	18.8	LOS B	16.4	118.0	1.00	0.96	1.42	48.5
9u	U	All MCs	3	0.0	3	0.0	0.846	21.2	LOS C	16.4	118.0	1.00	0.96	1.42	48.5
Approach			903	3.2	903	3.2	0.846	12.9	LOS B	16.4	118.0	1.00	0.96	1.42	49.2
West: Saddle Road															
10	L2	All MCs	6	0.0	6	0.0	0.028	6.1	LOS A	0.2	1.6	0.87	0.64	0.87	10.2
11	T1	All MCs	2	0.0	2	0.0	0.028	6.1	LOS A	0.2	1.6	0.87	0.64	0.87	10.2
12	R2	All MCs	6	50.0	6	50.0	0.028	8.2	LOS A	0.2	1.6	0.87	0.64	0.87	10.2
12u	U	All MCs	1	0.0	1	0.0	0.028	17.8	LOS B	0.2	1.6	0.87	0.64	0.87	17.0
Approach			15	20.0	15	20.0	0.028	7.7	LOS A	0.2	1.6	0.87	0.64	0.87	10.4
All Vehicles			1866	5.0	1866	5.0	0.846	11.0	LOS B	16.4	118.0	0.87	0.77	1.07	48.3

MOVEMENT SUMMARY

Site: 101 [Bruns Rbout 2024 PM background (Site Folder: Option A)]

Output produced by SIDRA INTERSECTION Version: 9.1.1.200

New Site
Site Category: (None)
Roundabout

Vehicle Movement Performance															
Mov ID	Turn	Mov Class	Demand Flows		Arrival Flows		Deg. Satn	Aver. Delay	Level of Service	95% Back Of Queue		Prop. Que	Eff. Stop Rate	Aver. No. of Cycles	Aver. Speed
			[Total	HV]	[Total	HV]				[Veh.	Dist]				
			veh/h	%	veh/h	%	v/c	sec		veh	m				km/h

			veh/h	%	veh/h	%	v/c	sec		veh	m				km/h
South: Gulgan Road															
1	L2	All MCs	1	0.0	1	0.0	0.409	4.3	LOS A	3.2	22.6	0.49	0.54	0.49	51.8
2	T1	All MCs	243	3.7	243	3.7	0.409	4.3	LOS A	3.2	22.6	0.49	0.54	0.49	52.1
3	R2	All MCs	288	1.0	288	1.0	0.409	10.3	LOS B	3.2	22.6	0.49	0.54	0.49	51.2
3u	U	All MCs	1	0.0	1	0.0	0.409	12.7	LOS B	3.2	22.6	0.49	0.54	0.49	51.3
Approach			533	2.3	533	2.3	0.409	7.6	LOS A	3.2	22.6	0.49	0.54	0.49	51.6
East: Pacific Mwy															
4	L2	All MCs	2	0.0	2	0.0	0.157	5.0	LOS A	1.0	7.1	0.57	0.65	0.57	49.9
5	T1	All MCs	1	0.0	1	0.0	0.157	4.9	LOS A	1.0	7.1	0.57	0.65	0.57	50.2
6	R2	All MCs	167	4.2	167	4.2	0.157	11.1	LOS B	1.0	7.1	0.57	0.65	0.57	49.2
6u	U	All MCs	3	0.0	3	0.0	0.157	13.4	LOS B	1.0	7.1	0.57	0.65	0.57	49.4
Approach			173	4.0	173	4.0	0.157	11.0	LOS B	1.0	7.1	0.57	0.65	0.57	49.2
North: Tweed Street															
7	L2	All MCs	50	8.0	50	8.0	0.384	5.3	LOS A	2.7	19.7	0.59	0.51	0.59	52.9
8	T1	All MCs	375	2.9	375	2.9	0.384	5.1	LOS A	2.7	19.7	0.59	0.51	0.59	53.3
9	R2	All MCs	1	0.0	1	0.0	0.384	11.0	LOS B	2.7	19.7	0.59	0.51	0.59	52.4
9u	U	All MCs	3	0.0	3	0.0	0.384	13.5	LOS B	2.7	19.7	0.59	0.51	0.59	52.4
Approach			429	3.5	429	3.5	0.384	5.2	LOS A	2.7	19.7	0.59	0.51	0.59	53.3
West: Saddle Road															
10	L2	All MCs	3	0.0	3	0.0	0.008	3.3	LOS A	0.0	0.3	0.69	0.43	0.69	10.6
11	T1	All MCs	2	0.0	2	0.0	0.008	3.3	LOS A	0.0	0.3	0.69	0.43	0.69	10.6
12	R2	All MCs	1	0.0	1	0.0	0.008	3.3	LOS A	0.0	0.3	0.69	0.43	0.69	10.6
12u	U	All MCs	1	0.0	1	0.0	0.008	15.0	LOS B	0.0	0.3	0.69	0.43	0.69	18.0
Approach			7	0.0	7	0.0	0.008	5.0	LOS A	0.0	0.3	0.69	0.43	0.69	11.2
All Vehicles			1142	3.0	1142	3.0	0.409	7.2	LOS A	3.2	22.6	0.54	0.55	0.54	50.7

MOVEMENT SUMMARY

 **Site: 101 [Bruns Rbout 2034 PM background (Site Folder: Option A)]**

Output produced by SIDRA INTERSECTION Version: 9.1.1.200

New Site
Site Category: (None)
Roundabout

Vehicle Movement Performance															
Mov ID	Turn	Mov Class	Demand Flows		Arrival Flows		Deg. Satn	Aver. Delay	Level of Service	95% Back Of Queue		Prop. Que	Eff. Stop Rate	Aver. No. of Cycles	Aver. Speed
			[Total]	[HV]	[Total]	[HV]				[Veh.]	[Dist]				
			veh/h	%	veh/h	%	v/c	sec		veh	m				km/h
South: Gulgan Road															
1	L2	All MCs	2	0.0	2	0.0	0.614	5.2	LOS A	5.9	42.4	0.72	0.60	0.72	51.1
2	T1	All MCs	337	3.6	337	3.6	0.614	5.2	LOS A	5.9	42.4	0.72	0.60	0.72	51.3
3	R2	All MCs	401	1.2	401	1.2	0.614	11.2	LOS B	5.9	42.4	0.72	0.60	0.72	50.5
3u	U	All MCs	2	0.0	2	0.0	0.614	13.6	LOS B	5.9	42.4	0.72	0.60	0.72	50.5
Approach			742	2.3	742	2.3	0.614	8.5	LOS A	5.9	42.4	0.72	0.60	0.72	50.9

East: Pacific Mwy															
4	L2	All MCs	3	0.0	3	0.0	0.260	6.0	LOS A	1.9	13.6	0.74	0.69	0.74	49.3
5	T1	All MCs	2	0.0	2	0.0	0.260	6.0	LOS A	1.9	13.6	0.74	0.69	0.74	49.6
6	R2	All MCs	232	3.9	232	3.9	0.260	12.1	LOS B	1.9	13.6	0.74	0.69	0.74	48.7
6u	U	All MCs	5	0.0	5	0.0	0.260	14.4	LOS B	1.9	13.6	0.74	0.69	0.74	48.8
Approach			242	3.7	242	3.7	0.260	12.1	LOS B	1.9	13.6	0.74	0.69	0.74	48.7
North: Tweed Street															
7	L2	All MCs	70	8.6	70	8.6	0.609	8.0	LOS A	6.2	44.8	0.83	0.71	0.94	51.6
8	T1	All MCs	521	2.9	521	2.9	0.609	7.7	LOS A	6.2	44.8	0.83	0.71	0.94	52.1
9	R2	All MCs	2	0.0	2	0.0	0.609	13.6	LOS B	6.2	44.8	0.83	0.71	0.94	51.2
9u	U	All MCs	5	0.0	5	0.0	0.609	16.0	LOS B	6.2	44.8	0.83	0.71	0.94	51.2
Approach			598	3.5	598	3.5	0.609	7.8	LOS A	6.2	44.8	0.83	0.71	0.94	52.0
West: Saddle Road															
10	L2	All MCs	5	0.0	5	0.0	0.021	6.3	LOS A	0.2	1.1	0.88	0.61	0.88	10.2
11	T1	All MCs	6	0.0	6	0.0	0.021	6.3	LOS A	0.2	1.1	0.88	0.61	0.88	10.2
12	R2	All MCs	1	0.0	1	0.0	0.021	6.3	LOS A	0.2	1.1	0.88	0.61	0.88	10.2
12u	U	All MCs	1	0.0	1	0.0	0.021	18.0	LOS B	0.2	1.1	0.88	0.61	0.88	16.9
Approach			13	0.0	13	0.0	0.021	7.2	LOS A	0.2	1.1	0.88	0.61	0.88	10.5
All Vehicles			1595	2.9	1595	2.9	0.614	8.8	LOS A	6.2	44.8	0.77	0.65	0.81	49.4

MOVEMENT SUMMARY

 **Site: 101 [Bruns Rbout 2034 PM development (Site Folder: Option A)]**

Output produced by SIDRA INTERSECTION Version: 9.1.1.200

New Site
Site Category: (None)
Roundabout

Vehicle Movement Performance

Mov ID	Turn	Mov Class	Demand Flows		Arrival Flows		Deg. Satn	Aver. Delay	Level of Service	95% Back Of Queue		Prop. Que	Eff. Stop Rate	Aver. No. of Cycles	Aver. Speed
			[Total veh/h]	[HV %]	[Total veh/h]	[HV %]				[Veh.]	[Dist]				
South: Gulgan Road															
1	L2	All MCs	2	0.0	2	0.0	0.806	8.3	LOS A	13.6	98.2	0.94	0.74	1.09	49.7
2	T1	All MCs	480	5.6	480	5.6	0.806	8.4	LOS A	13.6	98.2	0.94	0.74	1.09	49.9
3	R2	All MCs	446	2.0	446	2.0	0.806	14.3	LOS B	13.6	98.2	0.94	0.74	1.09	49.1
3u	U	All MCs	38	10.5	38	10.5	0.806	17.0	LOS B	13.6	98.2	0.94	0.74	1.09	48.9
Approach			966	4.1	966	4.1	0.806	11.5	LOS B	13.6	98.2	0.94	0.74	1.09	49.5
East: Pacific Mwy															
4	L2	All MCs	3	0.0	3	0.0	0.303	6.9	LOS A	2.4	17.0	0.85	0.72	0.85	49.0
5	T1	All MCs	2	0.0	2	0.0	0.303	6.8	LOS A	2.4	17.0	0.85	0.72	0.85	49.3
6	R2	All MCs	232	3.9	232	3.9	0.303	13.0	LOS B	2.4	17.0	0.85	0.72	0.85	48.4
6u	U	All MCs	5	0.0	5	0.0	0.303	15.3	LOS B	2.4	17.0	0.85	0.72	0.85	48.5
Approach			242	3.7	242	3.7	0.303	12.9	LOS B	2.4	17.0	0.85	0.72	0.85	48.4
North: Tweed Street															
7	L2	All MCs	70	8.6	70	8.6	0.772	13.3	LOS B	11.5	83.2	1.00	0.96	1.40	48.7

8	T1	All MCs	594	3.9	594	3.9	0.772	13.0	LOS B	11.5	83.2	1.00	0.96	1.40	49.1
9	R2	All MCs	2	0.0	2	0.0	0.772	18.8	LOS B	11.5	83.2	1.00	0.96	1.40	48.4
9u	U	All MCs	5	0.0	5	0.0	0.772	21.2	LOS C	11.5	83.2	1.00	0.96	1.40	48.4
Approach			671	4.3	671	4.3	0.772	13.1	LOS B	11.5	83.2	1.00	0.96	1.40	49.1
West: Saddle Road															
10	L2	All MCs	5	0.0	5	0.0	0.026	11.3	LOS B	0.2	1.5	1.00	0.75	1.00	10.1
11	T1	All MCs	3	0.0	3	0.0	0.026	11.3	LOS B	0.2	1.5	1.00	0.75	1.00	10.1
12	R2	All MCs	1	0.0	1	0.0	0.026	11.3	LOS B	0.2	1.5	1.00	0.75	1.00	10.1
12u	U	All MCs	1	0.0	1	0.0	0.026	22.9	LOS C	0.2	1.5	1.00	0.75	1.00	16.9
Approach			10	0.0	10	0.0	0.026	12.4	LOS B	0.2	1.5	1.00	0.75	1.00	10.6
All Vehicles			1889	4.1	1889	4.1	0.806	12.2	LOS B	13.6	98.2	0.95	0.82	1.17	48.3

MOVEMENT SUMMARY

Site: 101 [Tandys 2024 AM background (Site Folder: Option A)]

Output produced by SIDRA INTERSECTION Version: 9.1.1.200

New Site
Site Category: (None)
Give-Way (Two-Way)

Vehicle Movement Performance

Mov ID	Turn	Mov Class	Demand Flows		Arrival Flows		Deg. Satn	Aver. Delay	Level of Service	95% Back Of Queue		Prop. Que	Eff. Stop Rate	Aver. No. of Cycles	Aver. Speed
			[Total veh/h]	[HV %]	[Total veh/h]	[HV %]				[Veh. veh]	[Dist. m]				
South: Gulgan Road (S)															
2	T1	All MCs	433	5.8	433	5.8	0.282	0.0	LOS A	0.6	4.5	0.14	0.16	0.14	77.1
3	R2	All MCs	16	6.7	16	6.7	0.282	20.5	LOS B	0.6	4.5	0.14	0.16	0.14	68.3
3u	U	All MCs	14	0.0	14	0.0	0.282	26.7	LOS B	0.6	4.5	0.14	0.16	0.14	62.8
Approach			462	5.7	462	5.7	0.282	1.5	NA	0.6	4.5	0.14	0.16	0.14	76.2
East: Tandys Lane															
4	L2	All MCs	20	5.3	20	5.3	0.046	9.6	LOS A	0.2	1.2	0.60	0.77	0.60	58.1
6	R2	All MCs	6	0.0	6	0.0	0.046	18.7	LOS B	0.2	1.2	0.60	0.77	0.60	59.5
Approach			26	4.0	26	4.0	0.046	11.8	LOS A	0.2	1.2	0.60	0.77	0.60	58.4
North: Gulgan Road (N)															
7	L2	All MCs	4	0.0	4	0.0	0.002	6.9	LOS A	0.0	0.0	0.00	0.63	0.00	64.6
8	T1	All MCs	567	3.3	567	3.3	0.297	0.1	LOS A	0.0	0.0	0.00	0.00	0.00	79.8
Approach			572	3.3	572	3.3	0.297	0.1	NA	0.0	0.0	0.00	0.00	0.00	79.7
All Vehicles			1060	4.4	1060	4.4	0.297	1.0	NA	0.6	4.5	0.08	0.09	0.08	77.4

MOVEMENT SUMMARY

Site: 101 [Tandys 2034 AM background (Site Folder: Option A)]

Output produced by SIDRA INTERSECTION Version: 9.1.1.200

New Site
Site Category: (None)
Give-Way (Two-Way)

Vehicle Movement Performance															
Mov ID	Turn	Mov Class	Demand Flows		Arrival Flows		Deg. Satn	Aver. Delay	Level of Service	95% Back Of Queue		Prop. Que	Eff. Stop Rate	Aver. No. of Cycles	Aver. Speed
			[Total	HV]	[Total	HV]				[Veh.	Dist]				
			veh/h	%	veh/h	%	v/c	sec		veh	m				
South: Gulgan Road (S)															
2	T1	All MCs	603	5.9	603	5.9	0.436	0.8	LOS A	2.2	16.5	0.20	0.24	0.28	73.4
3	R2	All MCs	23	9.1	23	9.1	0.436	40.6	LOS C	2.2	16.5	0.20	0.24	0.28	64.6
3u	U	All MCs	19	0.0	19	0.0	0.436	56.4	LOS D	2.2	16.5	0.20	0.24	0.28	60.3
Approach			645	5.9	645	5.9	0.436	3.9	NA	2.2	16.5	0.20	0.24	0.28	72.6
East: Tandys Lane															
4	L2	All MCs	28	7.4	28	7.4	0.117	12.0	LOS A	0.4	2.7	0.77	0.91	0.77	52.7
6	R2	All MCs	8	0.0	8	0.0	0.117	36.9	LOS C	0.4	2.7	0.77	0.91	0.77	54.3
Approach			37	5.7	37	5.7	0.117	17.7	LOS B	0.4	2.7	0.77	0.91	0.77	53.1
North: Gulgan Road (N)															
7	L2	All MCs	6	0.0	6	0.0	0.003	6.9	LOS A	0.0	0.0	0.00	0.63	0.00	64.6
8	T1	All MCs	788	3.3	788	3.3	0.413	0.2	LOS A	0.0	0.0	0.00	0.00	0.00	79.7
Approach			795	3.3	795	3.3	0.413	0.2	NA	0.0	0.0	0.00	0.01	0.00	79.5
All Vehicles			1477	4.5	1477	4.5	0.436	2.2	NA	2.2	16.5	0.11	0.13	0.14	75.4

MOVEMENT SUMMARY

Site: 101 [Tandys 2034 AM development (Site Folder: Option A)]

Output produced by SIDRA INTERSECTION Version: 9.1.1.200

New Site
Site Category: (None)
Give-Way (Two-Way)

Vehicle Movement Performance															
Mov ID	Turn	Mov Class	Demand Flows		Arrival Flows		Deg. Satn	Aver. Delay	Level of Service	95% Back Of Queue		Prop. Que	Eff. Stop Rate	Aver. No. of Cycles	Aver. Speed
			[Total	HV]	[Total	HV]				[Veh.	Dist]				
			veh/h	%	veh/h	%	v/c	sec		veh	m				
South: Gulgan Road (S)															
2	T1	All MCs	876	7.3	876	7.3	0.641	8.2	LOS A	10.2	75.5	0.21	0.24	0.60	62.7
3	R2	All MCs	23	9.1	23	9.1	0.641	81.7	LOS F	10.2	75.5	0.21	0.24	0.60	56.2
3u	U	All MCs	19	0.0	19	0.0	0.641	118.2	LOS F	10.2	75.5	0.21	0.24	0.60	52.9
Approach			918	7.2	918	7.2	0.641	12.3	NA	10.2	75.5	0.21	0.24	0.60	62.3
East: Tandys Lane															
4	L2	All MCs	28	7.4	28	7.4	0.264	16.9	LOS B	0.8	5.9	0.91	0.99	1.01	42.3
6	R2	All MCs	8	0.0	8	0.0	0.264	94.5	LOS F	0.8	5.9	0.91	0.99	1.01	43.4
Approach			37	5.7	37	5.7	0.264	34.7	LOS C	0.8	5.9	0.91	0.99	1.01	42.6
North: Gulgan Road (N)															

7	L2	All MCs	6	0.0	6	0.00	0.003	6.9	LOS A	0.0	0.0	0.00	0.63	0.00	64.6
8	T1	All MCs	944	4.0	944	4.00	0.497	0.2	LOS A	0.0	0.0	0.00	0.00	0.00	79.5
Approach			951	4.0	951	4.00	0.497	0.3	NA	0.0	0.0	0.00	0.00	0.00	79.4
All Vehicles			1905	5.6	1905	5.60	0.641	6.7	NA	10.2	75.5	0.12	0.13	0.31	69.1

MOVEMENT SUMMARY

Site: 101 [Tandys 2024 PM background (Site Folder: Option A)]

Output produced by SIDRA INTERSECTION Version: 9.1.1.200

New Site
Site Category: (None)
Give-Way (Two-Way)

Vehicle Movement Performance

Mov ID	Turn	Mov Class	Demand Flows		Arrival Flows		Deg. Satn	Aver. Delay	Level of Service	95% Back Of Queue		Prop. Que	Eff. Stop Rate	Aver. No. of Cycles	Aver. Speed
			[Total veh/h]	[HV %]	[Total veh/h]	[HV %]				[Veh. veh]	[Dist m]				
South: Gulgan Road (S)															
2	T1	All MCs	544	1.4	544	1.4	0.330	0.0	LOS A	0.6	4.1	0.11	0.12	0.11	77.9
3	R2	All MCs	16	13.3	16	13.3	0.330	15.4	LOS B	0.6	4.1	0.11	0.12	0.11	66.5
3u	U	All MCs	19	0.0	19	0.0	0.330	17.5	LOS B	0.6	4.1	0.11	0.12	0.11	63.4
Approach			579	1.6	579	1.6	0.330	1.0	NA	0.6	4.1	0.11	0.12	0.11	77.0
East: Tandys Lane															
4	L2	All MCs	21	0.0	21	0.0	0.055	8.3	LOS A	0.2	1.3	0.58	0.72	0.58	59.4
6	R2	All MCs	9	11.1	9	11.1	0.055	19.9	LOS B	0.2	1.3	0.58	0.72	0.58	56.3
Approach			31	3.4	31	3.4	0.055	11.9	LOS A	0.2	1.3	0.58	0.72	0.58	58.4
North: Gulgan Road (N)															
7	L2	All MCs	7	0.0	7	0.0	0.004	6.9	LOS A	0.0	0.0	0.00	0.63	0.00	64.6
8	T1	All MCs	384	2.2	384	2.2	0.200	0.1	LOS A	0.0	0.0	0.00	0.00	0.00	79.9
Approach			392	2.2	392	2.2	0.200	0.2	NA	0.0	0.0	0.00	0.01	0.00	79.5
All Vehicles			1001	1.9	1001	1.9	0.330	1.0	NA	0.6	4.1	0.08	0.10	0.08	77.2

MOVEMENT SUMMARY

Site: 101 [Tandys 2034 PM background (Site Folder: Option A)]

Output produced by SIDRA INTERSECTION Version: 9.1.1.200

New Site
Site Category: (None)
Give-Way (Two-Way)

Vehicle Movement Performance

Mov ID	Turn	Mov Class	Demand Flows		Arrival Flows		Deg. Satn	Aver. Delay	Level of Service	95% Back Of Queue		Prop. Que	Eff. Stop Rate	Aver. No. of Cycles	Aver. Speed
			[Total veh/h]	[HV %]	[Total veh/h]	[HV %]				[Veh. veh]	[Dist m]				

South: Gulgan Road (S)															
2	T1	All MCs	756	1.3	756	1.3	0.467	0.3	LOS A	1.5	10.6	0.13	0.16	0.18	76.7
3	R2	All MCs	19	0.0	19	0.0	0.467	19.9	LOS B	1.5	10.6	0.13	0.16	0.18	70.7
3u	U	All MCs	26	0.0	26	0.0	0.467	27.6	LOS B	1.5	10.6	0.13	0.16	0.18	62.6
Approach			801	1.2	801	1.2	0.467	1.7	NA	1.5	10.6	0.13	0.16	0.18	76.0
East: Tandys Lane															
4	L2	All MCs	29	0.0	29	0.0	0.168	9.3	LOS A	0.5	3.5	0.75	0.89	0.76	52.2
6	R2	All MCs	14	15.4	14	15.4	0.168	44.5	LOS D	0.5	3.5	0.75	0.89	0.76	48.9
Approach			43	4.9	43	4.9	0.168	20.4	LOS B	0.5	3.5	0.75	0.89	0.76	51.1
North: Gulgan Road (N)															
7	L2	All MCs	9	0.0	9	0.0	0.005	6.9	LOS A	0.0	0.0	0.00	0.63	0.00	64.6
8	T1	All MCs	535	2.4	535	2.4	0.278	0.1	LOS A	0.0	0.0	0.00	0.00	0.00	79.8
Approach			544	2.3	544	2.3	0.278	0.2	NA	0.0	0.0	0.00	0.01	0.00	79.5
All Vehicles			1388	1.7	1388	1.7	0.467	1.7	NA	1.5	10.6	0.10	0.12	0.13	76.2

MOVEMENT SUMMARY

▼ Site: 101 [Tandys 2034 PM development (Site Folder: Option A)]

Output produced by SIDRA INTERSECTION Version: 9.1.1.200

New Site
Site Category: (None)
Give-Way (Two-Way)

Vehicle Movement Performance

Mov ID	Turn	Mov Class	Demand Flows		Arrival Flows		Deg. Satn	Aver. Delay	Level of Service	95% Back Of Queue		Prop. Que	Eff. Stop Rate	Aver. No. of Cycles	Aver. Speed
			[Total]	[HV]	[Total]	[HV]				[Veh.]	[Dist]				
			veh/h	%	veh/h	%	v/c	sec		veh	m				km/h
South: Gulgan Road (S)															
2	T1	All MCs	914	2.9	914	2.9	0.570	1.2	LOS A	3.1	22.4	0.13	0.16	0.28	75.0
3	R2	All MCs	19	0.0	19	0.0	0.570	27.6	LOS B	3.1	22.4	0.13	0.16	0.28	69.3
3u	U	All MCs	26	0.0	26	0.0	0.570	41.0	LOS C	3.1	22.4	0.13	0.16	0.28	61.4
Approach			959	2.7	959	2.7	0.570	2.8	NA	3.1	22.4	0.13	0.16	0.28	74.5
East: Tandys Lane															
4	L2	All MCs	29	0.0	29	0.0	0.366	13.8	LOS A	0.9	6.7	0.88	1.01	1.10	40.4
6	R2	All MCs	14	15.4	14	15.4	0.366	99.7	LOS F	0.9	6.7	0.88	1.01	1.10	38.4
Approach			43	4.9	43	4.9	0.366	41.0	LOS C	0.9	6.7	0.88	1.01	1.10	39.7
North: Gulgan Road (N)															
7	L2	All MCs	9	0.0	9	0.0	0.005	6.9	LOS A	0.0	0.0	0.00	0.63	0.00	64.6
8	T1	All MCs	648	3.9	648	3.9	0.341	0.1	LOS A	0.0	0.0	0.00	0.00	0.00	79.7
Approach			658	3.8	658	3.8	0.341	0.2	NA	0.0	0.0	0.00	0.01	0.00	79.5
All Vehicles			1660	3.2	1660	3.2	0.570	2.8	NA	3.1	22.4	0.10	0.12	0.19	74.6

MOVEMENT SUMMARY

 **Site: 101 [New Mullum Rd Rbout 2024 AM background (Site Folder: Option A)]**

Output produced by SIDRA INTERSECTION Version: 9.1.1.200

New Site
Site Category: (None)
Roundabout

Vehicle Movement Performance															
Mov ID	Turn	Mov Class	Demand Flows		Arrival Flows		Deg. Satn	Aver. Delay	Level of Service	95% Back Of Queue		Prop. Que	Eff. Stop Rate	Aver. No. of Cycles	Aver. Speed
			[Total veh/h]	[HV %]	[Total veh/h]	[HV %]				[Veh. veh]	[Dist m]				
South: Gulgan Road (S)															
1	L2	All MCs	307	5.5	307	5.5	0.302	6.1	LOS A	1.9	13.9	0.65	0.62	0.65	53.0
2	T1	All MCs	15	6.7	15	6.7	0.025	6.9	LOS A	0.1	0.9	0.58	0.58	0.58	52.7
3u	U	All MCs	1	0.0	1	0.0	0.025	14.9	LOS B	0.1	0.9	0.58	0.58	0.58	52.0
Approach			323	5.6	323	5.6	0.302	6.2	LOS A	1.9	13.9	0.65	0.62	0.65	53.0
North: Gulgan Road (N)															
8	T1	All MCs	25	4.0	25	4.0	0.031	5.0	LOS A	0.1	0.9	0.38	0.44	0.38	54.2
9	R2	All MCs	536	3.5	536	3.5	0.415	10.5	LOS B	2.5	17.9	0.45	0.63	0.45	49.5
9u	U	All MCs	1	0.0	1	0.0	0.415	12.8	LOS B	2.5	17.9	0.45	0.63	0.45	49.7
Approach			562	3.6	562	3.6	0.415	10.2	LOS B	2.5	17.9	0.45	0.62	0.45	49.7
West: Mullumbimby Road															
10	L2	All MCs	412	6.1	412	6.1	0.244	0.0	LOS A	1.5	10.8	0.10	0.02	0.10	10.0
12	R2	All MCs	240	6.3	240	6.3	0.174	0.1	LOS A	0.9	6.9	0.10	0.02	0.10	10.0
12u	U	All MCs	1	0.0	1	0.0	0.174	11.7	LOS B	0.9	6.9	0.10	0.02	0.10	16.2
Approach			653	6.1	653	6.1	0.244	0.1	LOS A	1.5	10.8	0.10	0.02	0.10	10.0
All Vehicles			1538	5.1	1538	5.1	0.415	5.1	LOS A	2.5	17.9	0.34	0.36	0.34	18.7

MOVEMENT SUMMARY

 **Site: 101 [New Mullum Rd Rbout 2034 AM background (Site Folder: Option A)]**

Output produced by SIDRA INTERSECTION Version: 9.1.1.200

New Site
Site Category: (None)
Roundabout

Vehicle Movement Performance															
Mov ID	Turn	Mov Class	Demand Flows		Arrival Flows		Deg. Satn	Aver. Delay	Level of Service	95% Back Of Queue		Prop. Que	Eff. Stop Rate	Aver. No. of Cycles	Aver. Speed
			[Total veh/h]	[HV %]	[Total veh/h]	[HV %]				[Veh. veh]	[Dist m]				
South: Gulgan Road (S)															
1	L2	All MCs	427	5.4	427	5.4	0.536	9.8	LOS A	4.9	35.6	0.90	0.82	1.06	50.7
2	T1	All MCs	22	9.1	22	9.1	0.048	8.8	LOS A	0.2	1.8	0.72	0.70	0.72	51.7
3u	U	All MCs	1	0.0	1	0.0	0.048	16.6	LOS B	0.2	1.8	0.72	0.70	0.72	51.0
Approach			450	5.6	450	5.6	0.536	9.8	LOS A	4.9	35.6	0.89	0.81	1.04	50.7
North: Gulgan Road (N)															
8	T1	All MCs	36	5.6	36	5.6	0.049	5.7	LOS A	0.2	1.5	0.45	0.50	0.45	53.8

9	R2	All MCs	744	3.5	744	3.5	0.613	12.0	LOS B	5.1	37.0	0.65	0.70	0.69	48.9
9u	U	All MCs	1	0.0	1	0.0	0.613	14.3	LOS B	5.1	37.0	0.65	0.70	0.69	49.1
Approach			781	3.6	781	3.6	0.613	11.7	LOS B	5.1	37.0	0.64	0.69	0.68	49.1
West: Mullumbimby Road															
10	L2	All MCs	574	6.1	574	6.1	0.342	0.1	LOS A	2.4	17.9	0.14	0.04	0.14	10.0
12	R2	All MCs	334	6.3	334	6.3	0.244	0.1	LOS A	1.5	10.9	0.14	0.04	0.14	10.0
12u	U	All MCs	1	0.0	1	0.0	0.244	11.8	LOS B	1.5	10.9	0.14	0.04	0.14	16.2
Approach			909	6.2	909	6.2	0.342	0.1	LOS A	2.4	17.9	0.14	0.04	0.14	10.0
All Vehicles			2140	5.1	2140	5.1	0.613	6.4	LOS A	5.1	37.0	0.48	0.44	0.53	18.6

MOVEMENT SUMMARY

 **Site: 101 [New Mullum Rd Rbout 2034 AM development (Site Folder: Option A)]**

Output produced by SIDRA INTERSECTION Version: 9.1.1.200

New Site
Site Category: (None)
Roundabout

Vehicle Movement Performance

Mov ID	Turn	Mov Class	Demand Flows		Arrival Flows		Deg. Satn	Aver. Delay	Level of Service	95% Back Of Queue		Prop. Que	Eff. Stop Rate	Aver. No. of Cycles	Aver. Speed
			[Total veh/h]	[HV %]	[Total veh/h]	[HV %]				[Veh.]	[Dist] m				
South: Gulgan Road (S)															
1	L2	All MCs	427	5.4	427	5.4	0.702	17.8	LOS B	8.5	62.6	1.00	1.05	1.47	45.6
2	T1	All MCs	114	9.6	114	9.6	0.303	11.5	LOS B	1.9	14.0	0.88	0.81	0.88	50.0
3u	U	All MCs	1	0.0	1	0.0	0.303	19.2	LOS B	1.9	14.0	0.88	0.81	0.88	49.4
Approach			542	6.3	542	6.3	0.702	16.5	LOS B	8.5	62.6	0.97	1.00	1.35	46.5
North: Gulgan Road (N)															
8	T1	All MCs	36	5.6	36	5.6	0.051	5.7	LOS A	0.2	1.6	0.48	0.52	0.48	53.6
9	R2	All MCs	772	3.8	772	3.8	0.760	14.0	LOS B	9.8	71.6	0.83	0.79	1.00	47.8
9u	U	All MCs	125	10.4	125	10.4	0.760	16.6	LOS B	9.8	71.6	0.83	0.79	1.00	47.6
Approach			933	4.7	933	4.7	0.760	14.0	LOS B	9.8	71.6	0.81	0.78	0.98	48.0
West: Mullumbimby Road															
10	L2	All MCs	616	6.5	616	6.5	0.464	1.2	LOS A	3.2	23.8	0.51	0.31	0.51	10.0
12	R2	All MCs	334	6.3	334	6.3	0.317	1.4	LOS A	1.8	13.3	0.47	0.29	0.47	10.0
12u	U	All MCs	1	0.0	1	0.0	0.317	13.0	LOS B	1.8	13.3	0.47	0.29	0.47	16.1
Approach			951	6.4	951	6.4	0.464	1.3	LOS A	3.2	23.8	0.49	0.30	0.49	10.0
All Vehicles			2426	5.7	2426	5.7	0.760	9.6	LOS A	9.8	71.6	0.72	0.64	0.87	19.3

MOVEMENT SUMMARY

 **Site: 101 [New Mullum Rd Rbout 2024 PM background (Site Folder: Option A)]**

Output produced by SIDRA INTERSECTION Version: 9.1.1.200

New Site
Site Category: (None)
Roundabout

Vehicle Movement Performance															
Mov ID	Turn	Mov Class	Demand Flows		Arrival Flows		Deg. Satn	Aver. Delay	Level of Service	95% Back Of Queue		Prop. Que	Eff. Stop Rate	Aver. No. of Cycles	Aver. Speed
			[Total]	HV]	[Total]	HV]				[Veh.	Dist]				
			veh/h	% veh/h	%	v/c	sec	veh	m			km/h			
South: Gulgan Road (S)															
1	L2	All MCs	303	7.9	303	7.90	2.68	5.2	LOS A	1.5	11.5	0.53	0.55	0.53	53.4
2	T1	All MCs	27	11.1	27	11.10	0.40	6.0	LOS A	0.2	1.3	0.49	0.53	0.49	53.2
3u	U	All MCs	1	0.0	1	0.0	0.04	13.9	LOS B	0.2	1.3	0.49	0.53	0.49	52.5
Approach			331	8.2	331	8.20	2.68	5.3	LOS A	1.5	11.5	0.52	0.55	0.52	53.4
North: Gulgan Road (N)															
8	T1	All MCs	26	3.8	26	3.80	0.33	5.1	LOS A	0.1	1.0	0.40	0.46	0.40	54.1
9	R2	All MCs	373	2.1	373	2.10	0.297	10.4	LOS B	1.6	11.4	0.42	0.63	0.42	49.7
9u	U	All MCs	1	0.0	1	0.0	0.297	12.8	LOS B	1.6	11.4	0.42	0.63	0.42	49.8
Approach			400	2.3	400	2.30	0.297	10.1	LOS B	1.6	11.4	0.42	0.62	0.42	49.9
West: Mullumbimby Road															
10	L2	All MCs	518	1.4	518	1.40	0.305	0.1	LOS A	1.9	13.5	0.14	0.04	0.14	10.0
12	R2	All MCs	268	1.5	268	1.50	0.197	0.1	LOS A	1.1	7.5	0.14	0.04	0.14	10.0
12u	U	All MCs	1	0.0	1	0.0	0.197	11.8	LOS B	1.1	7.5	0.14	0.04	0.14	16.2
Approach			787	1.4	787	1.40	0.305	0.1	LOS A	1.9	13.5	0.14	0.04	0.14	10.0
All Vehicles			1518	3.1	1518	3.10	0.305	3.9	LOS A	1.9	13.5	0.30	0.30	0.30	16.4

MOVEMENT SUMMARY

 Site: 101 [New Mullum Rd Rbout 2034 PM background (Site Folder: Option A)]

Output produced by SIDRA INTERSECTION Version: 9.1.1.200

New Site
Site Category: (None)
Roundabout

Vehicle Movement Performance															
Mov ID	Turn	Mov Class	Demand Flows		Arrival Flows		Deg. Satn	Aver. Delay	Level of Service	95% Back Of Queue		Prop. Que	Eff. Stop Rate	Aver. No. of Cycles	Aver. Speed
			[Total]	HV]	[Total]	HV]				[Veh.	Dist]				
			veh/h	% veh/h	%	v/c	sec	veh	m			km/h			
South: Gulgan Road (S)															
1	L2	All MCs	397	2.3	397	2.30	0.384	6.1	LOS A	2.6	18.7	0.69	0.63	0.69	52.9
2	T1	All MCs	39	12.8	39	12.8	0.067	7.1	LOS A	0.3	2.4	0.60	0.61	0.60	52.7
3u	U	All MCs	1	0.0	1	0.0	0.067	14.9	LOS B	0.3	2.4	0.60	0.61	0.60	52.1
Approach			437	3.2	437	3.20	0.384	6.2	LOS A	2.6	18.7	0.68	0.63	0.68	52.9
North: Gulgan Road (N)															
8	T1	All MCs	37	5.4	37	5.40	0.052	5.9	LOS A	0.2	1.6	0.47	0.52	0.47	53.7

9	R2	All MCs	519	2.1	519	2.10.442	11.2	LOS B	2.8	19.9	0.57	0.67	0.57	49.2
9u	U	All MCs	1	0.0	1	0.0 0.44 2	13.6	LOS B	2.8	19.9	0.57	0.6 7	0.57	49.3
Approach			557	2.3	557	2.30.442	10.8	LOS B	2.8	19.9	0.56	0.66	0.56	49.5
West: Mullumbimby Road														
10	L2	All MCs	720	1.3	720	1.30.429	0.2	LOS A	3.2	22.9	0.21	0.07	0.21	10.0
12	R2	All MCs	373	1.6	373	1.60.278	0.2	LOS A	1.7	11.9	0.19	0.06	0.19	10.0
12u	U	All MCs	1	0.0	1	0.0 0.27 8	11.9	LOS B	1.7	11.9	0.19	0.0 6	0.19	16.2
Approach			1094	1.4	1094	1.40.429	0.2	LOS A	3.2	22.9	0.20	0.06	0.20	10.0
All Vehicles			2088	2.0	2088	2.00.442	4.3	LOS A	3.2	22.9	0.40	0.34	0.40	16.3

MOVEMENT SUMMARY

 **Site: 101 [New Mullum Rd Rbout 2034 PM development (Site Folder: Option A)]**

Output produced by SIDRA INTERSECTION Version: 9.1.1.200

New Site
Site Category: (None)
Roundabout

Vehicle Movement Performance

Mov ID	Turn	Mov Class	Demand Flows		Arrival Flows		Deg. Satn	Aver. Delay	Level of Service	95% Back Of Queue		Prop. Que	Eff. Stop Rate	Aver. No. of Cycles	Aver. Speed
			[Total veh/h]	[HV %]	[Total veh/h]	[HV %]				[Veh. veh]	[Dist m]				
South: Gulgan Road (S)															
1	L2	All MCs	397	2.3	397	2.3	0.433	6.9	LOS A	3.2	22.8	0.80	0.69	0.80	52.6
2	T1	All MCs	99	10.1	99	10.1	0.186	8.3	LOS A	1.0	7.4	0.70	0.68	0.70	52.3
3u	U	All MCs	1	0.0	1	0.0	0.186	16.1	LOS B	1.0	7.4	0.70	0.68	0.70	51.6
Approach			497	3.8	497	3.8	0.433	7.2	LOS A	3.2	22.8	0.78	0.69	0.78	52.5
North: Gulgan Road (N)															
8	T1	All MCs	37	5.4	37	5.4	0.053	5.9	LOS A	0.2	1.7	0.49	0.53	0.49	53.6
9	R2	All MCs	555	2.7	555	2.7	0.546	11.6	LOS B	4.2	30.1	0.66	0.69	0.68	48.8
9u	U	All MCs	73	11.0	73	11.0	0.546	14.2	LOS B	4.2	30.1	0.66	0.69	0.68	48.5
Approach			665	3.8	665	3.8	0.546	11.6	LOS B	4.2	30.1	0.65	0.68	0.67	49.0
West: Mullumbimby Road															
10	L2	All MCs	744	1.6	744	1.6	0.511	0.9	LOS A	3.8	27.0	0.45	0.25	0.45	10.0
12	R2	All MCs	373	1.6	373	1.6	0.326	1.0	LOS A	1.9	13.4	0.40	0.22	0.40	10.0
12u	U	All MCs	1	0.0	1	0.0	0.326	12.6	LOS B	1.9	13.4	0.40	0.22	0.40	16.1
Approach			1118	1.6	1118	1.6	0.511	0.9	LOS A	3.8	27.0	0.44	0.24	0.44	10.0
All Vehicles			2280	2.7	2280	2.7	0.546	5.4	LOS A	4.2	30.1	0.57	0.47	0.58	17.0

MOVEMENT SUMMARY

 **Site: 101 [Tyagarah Rbout 2024 AM background (Site Folder: Option A)]**

Output produced by SIDRA INTERSECTION Version: 9.1.1.200

New Site
Site Category: (None)
Roundabout

Vehicle Movement Performance															
Mov ID	Turn	Mov Class	Demand Flows		Arrival Flows		Deg. Satn	Aver. Delay	Level of Service	95% Back Of Queue		Prop. Que	Eff. Stop Rate	Aver. No. of Cycles	Aver. Speed
			[Total	HV]	[Total	HV]				[Veh.	Dist]				
			veh/h	%	veh/h	%	v/c	sec		veh	m				
South: Fox lane (Eastbound)															
1	L2	All MCs	2	0.0	2	0.0	0.012	3.8	LOS A	0.1	0.5	0.50	0.54	0.50	51.6
2	T1	All MCs	2	50.0	2	50.0	0.012	4.6	LOS A	0.1	0.5	0.50	0.54	0.50	51.5
3	R2	All MCs	8	12.5	8	12.5	0.012	11.4	LOS B	0.1	0.5	0.50	0.54	0.50	50.6
3u	U	All MCs	1	0.0	1	0.0	0.012	13.8	LOS B	0.1	0.5	0.50	0.54	0.50	51.0
Approach			14	15.4	14	15.4	0.012	9.3	LOS A	0.1	0.5	0.50	0.54	0.50	50.9
SouthEast: Pacific Mwy NB off-ramp (Northbound)															
21b	L3	All MCs	11	10.0	11	10.0	0.190	2.9	LOS A	0.9	6.7	0.13	0.32	0.13	55.5
21a	L1	All MCs	247	5.5	247	5.5	0.190	2.0	LOS A	0.9	6.7	0.13	0.32	0.13	56.2
23a	R1	All MCs	4	50.0	4	50.0	0.190	8.6	LOS A	0.9	6.7	0.13	0.32	0.13	53.5
23b	R3	All MCs	46	18.2	46	18.2	0.190	11.2	LOS B	0.9	6.7	0.13	0.32	0.13	54.6
Approach			308	8.2	308	8.2	0.190	3.5	LOS A	0.9	6.7	0.13	0.32	0.13	55.9
East: Pacific Mwy Overpass (Westbound)															
4	L2	All MCs	3	0.0	3	0.0	0.024	2.5	LOS A	0.1	0.6	0.02	0.46	0.02	54.7
5	T1	All MCs	19	5.6	19	5.6	0.024	2.2	LOS A	0.1	0.6	0.02	0.46	0.02	55.0
6	R2	All MCs	17	6.3	17	6.3	0.024	9.6	LOS A	0.1	0.6	0.02	0.46	0.02	53.9
6u	U	All MCs	1	0.0	1	0.0	0.024	12.3	LOS B	0.1	0.6	0.02	0.46	0.02	54.1
Approach			40	5.3	40	5.3	0.024	5.6	LOS A	0.1	0.6	0.02	0.46	0.02	54.4
West: Gulgan Rd (Southbound)															
10	L2	All MCs	4	0.0	4	0.0	0.197	2.7	LOS A	0.7	4.9	0.14	0.24	0.14	56.5
11	T1	All MCs	307	4.8	307	4.8	0.197	2.3	LOS A	0.7	4.9	0.14	0.24	0.14	56.8
12	R2	All MCs	1	0.0	1	0.0	0.197	9.8	LOS A	0.7	4.9	0.14	0.24	0.14	55.8
12u	U	All MCs	1	0.0	1	0.0	0.197	12.5	LOS B	0.7	4.9	0.14	0.24	0.14	55.8
Approach			314	4.7	314	4.7	0.197	2.4	LOS A	0.7	4.9	0.14	0.24	0.14	56.8
All Vehicles			676	6.5	676	6.5	0.197	3.3	LOS A	0.9	6.7	0.14	0.30	0.14	56.1

MOVEMENT SUMMARY

 **Site: 101 [Tyagarah Rbout 2034 AM background (Site Folder: Option A)]**

Output produced by SIDRA INTERSECTION Version: 9.1.1.200

New Site
Site Category: (None)
Roundabout

Vehicle Movement Performance															
Mov ID	Turn	Mov Class	Demand Flows		Arrival Flows		Deg. Satn	Aver. Delay	Level of Service	95% Back Of Queue		Prop. Que	Eff. Stop Rate	Aver. No. of Cycles	Aver. Speed
			[Total	HV]	[Total	HV]				[Veh.	Dist]				
			veh/h	%	veh/h	%	v/c	sec		veh	m				

South: Fox lane (Eastbound)															
1	L2	All MCs	3	0.0	3	0.0	0.017	4.5	LOS A	0.1	0.8	0.59	0.57	0.59	51.3
2	T1	All MCs	2	50.0	2	50.0	0.017	5.5	LOS A	0.1	0.8	0.59	0.57	0.59	51.3
3	R2	All MCs	12	18.2	12	18.2	0.017	12.3	LOS B	0.1	0.8	0.59	0.57	0.59	50.2
3u	U	All MCs	1	0.0	1	0.0	0.017	14.5	LOS B	0.1	0.8	0.59	0.57	0.59	50.8
Approach			18	17.6	18	17.6	0.017	10.3	LOS B	0.1	0.8	0.59	0.57	0.59	50.6
SouthEast: Pacific Mwy NB off-ramp (Northbound)															
21b	L3	All MCs	15	14.3	15	14.3	0.267	3.0	LOS A	1.4	10.2	0.17	0.33	0.17	55.2
21a	L1	All MCs	343	5.5	343	5.5	0.267	2.1	LOS A	1.4	10.2	0.17	0.33	0.17	56.0
23a	R1	All MCs	5	40.0	5	40.0	0.267	8.6	LOS A	1.4	10.2	0.17	0.33	0.17	53.6
23b	R3	All MCs	65	17.7	65	17.7	0.267	11.3	LOS B	1.4	10.2	0.17	0.33	0.17	54.4
Approach			428	8.1	428	8.1	0.267	3.6	LOS A	1.4	10.2	0.17	0.33	0.17	55.7
East: Pacific Mwy Overpass (Westbound)															
4	L2	All MCs	5	0.0	5	0.0	0.033	2.5	LOS A	0.1	0.8	0.02	0.45	0.02	54.7
5	T1	All MCs	26	8.0	26	8.0	0.033	2.2	LOS A	0.1	0.8	0.02	0.45	0.02	55.0
6	R2	All MCs	22	0.0	22	0.0	0.033	9.6	LOS A	0.1	0.8	0.02	0.45	0.02	54.1
6u	U	All MCs	1	0.0	1	0.0	0.033	12.3	LOS B	0.1	0.8	0.02	0.45	0.02	54.1
Approach			55	3.8	55	3.8	0.033	5.4	LOS A	0.1	0.8	0.02	0.45	0.02	54.6
West: Gulgan Rd (Southbound)															
10	L2	All MCs	6	0.0	6	0.0	0.279	2.7	LOS A	1.1	7.7	0.19	0.25	0.19	56.3
11	T1	All MCs	428	4.9	428	4.9	0.279	2.4	LOS A	1.1	7.7	0.19	0.25	0.19	56.5
12	R2	All MCs	2	0.0	2	0.0	0.279	9.8	LOS A	1.1	7.7	0.19	0.25	0.19	55.6
12u	U	All MCs	1	0.0	1	0.0	0.279	12.6	LOS B	1.1	7.7	0.19	0.25	0.19	55.6
Approach			438	4.8	438	4.8	0.279	2.5	LOS A	1.1	7.7	0.19	0.25	0.19	56.5
All Vehicles			939	6.5	939	6.5	0.279	3.3	LOS A	1.4	10.2	0.18	0.30	0.18	55.9

MOVEMENT SUMMARY

 **Site: 101 [Tyagarah Rbout 2034 AM development (Site Folder: Option A)]**

Output produced by SIDRA INTERSECTION Version: 9.1.1.200

New Site
Site Category: (None)
Roundabout

Vehicle Movement Performance															
Mov ID	Turn	Mov Class	Demand Flows		Arrival Flows		Deg. Satn	Aver. Delay	Level of Service	95% Back Of Queue		Prop. Que	Eff. Stop Rate	Aver. No. of Cycles	Aver. Speed
			[Total	HV]	[Total	HV]				[Veh.	Dist]				
			veh/h	%	veh/h	%	v/c	sec			veh	m			
South: Fox lane (Eastbound)															
1	L2	All MCs	3	0.0	3	0.0	0.019	5.1	LOS A	0.1	0.9	0.65	0.60	0.65	51.0
2	T1	All MCs	2	50.0	2	50.0	0.019	6.4	LOS A	0.1	0.9	0.65	0.60	0.65	50.9
3	R2	All MCs	12	18.2	12	18.2	0.019	13.0	LOS B	0.1	0.9	0.65	0.60	0.65	49.9
3u	U	All MCs	1	0.0	1	0.0	0.019	15.1	LOS B	0.1	0.9	0.65	0.60	0.65	50.4
Approach			18	17.6	18	17.6	0.019	11.0	LOS B	0.1	0.9	0.65	0.60	0.65	50.2
SouthEast: Pacific Mwy NB off-ramp (Northbound)															
21b	L3	All MCs	15	14.3	15	14.3	0.327	3.0	LOS A	1.8	13.4	0.18	0.31	0.18	55.3

21a	L1	All MCs	442	6.7	442	6.7	0.327	2.1	LOS A	1.8	13.4	0.18	0.31	0.18	56.1
23a	R1	All MCs	5	40.0	5	40.0	0.327	8.7	LOS A	1.8	13.4	0.18	0.31	0.18	53.7
23b	R3	All MCs	65	17.7	65	17.7	0.327	11.3	LOS B	1.8	13.4	0.18	0.31	0.18	54.5
Approach			527	8.6	527	8.6	0.327	3.4	LOS A	1.8	13.4	0.18	0.31	0.18	55.9
East: Pacific Mwy Overpass (Westbound)															
4	L2	All MCs	5	0.0	5	0.0	0.033	2.5	LOS A	0.1	0.8	0.02	0.45	0.02	54.7
5	T1	All MCs	26	8.0	26	8.0	0.033	2.2	LOS A	0.1	0.8	0.02	0.45	0.02	55.0
6	R2	All MCs	22	0.0	22	0.0	0.033	9.6	LOS A	0.1	0.8	0.02	0.45	0.02	54.1
6u	U	All MCs	1	0.0	1	0.0	0.033	12.3	LOS B	0.1	0.8	0.02	0.45	0.02	54.1
Approach			55	3.8	55	3.8	0.033	5.4	LOS A	0.1	0.8	0.02	0.45	0.02	54.6
West: Gulgan Rd (Southbound)															
10	L2	All MCs	6	0.0	6	0.0	0.279	2.7	LOS A	1.1	7.7	0.19	0.25	0.19	56.2
11	T1	All MCs	428	4.9	428	4.9	0.279	2.4	LOS A	1.1	7.7	0.19	0.25	0.19	56.5
12	R2	All MCs	2	0.0	2	0.0	0.279	9.8	LOS A	1.1	7.7	0.19	0.25	0.19	55.6
12u	U	All MCs	1	0.0	1	0.0	0.279	12.6	LOS B	1.1	7.7	0.19	0.25	0.19	55.6
Approach			438	4.8	438	4.8	0.279	2.5	LOS A	1.1	7.7	0.19	0.25	0.19	56.5
All Vehicles			1038	6.9	1038	6.9	0.327	3.2	LOS A	1.8	13.4	0.18	0.30	0.18	56.0

MOVEMENT SUMMARY

 Site: 101 [Tyagarah Rabout 2024 PM background (Site Folder: Option A)]

Output produced by SIDRA INTERSECTION Version: 9.1.1.200

New Site
Site Category: (None)
Roundabout

Vehicle Movement Performance

Mov ID	Turn	Mov Class	Demand Flows		Arrival Flows		Deg. Satn	Aver. Delay	Level of Service	95% Back Of Queue		Prop. Que	Eff. Stop Rate	Aver. No. of Cycles	Aver. Speed
			[Total veh/h]	[HV %]	[Total veh/h]	[HV %]				[Veh. veh]	[Dist. m]				
South: Fox lane (Eastbound)															
1	L2	All MCs	3	0.0	3	0.0	0.007	4.4	LOS A	0.0	0.3	0.57	0.52	0.57	52.3
2	T1	All MCs	1	0.0	1	0.0	0.007	4.2	LOS A	0.0	0.3	0.57	0.52	0.57	52.5
3	R2	All MCs	3	0.0	3	0.0	0.007	11.6	LOS B	0.0	0.3	0.57	0.52	0.57	51.7
3u	U	All MCs	1	0.0	1	0.0	0.007	14.4	LOS B	0.0	0.3	0.57	0.52	0.57	51.7
Approach			8	0.0	8	0.0	0.007	8.3	LOS A	0.0	0.3	0.57	0.52	0.57	52.0
SouthEast: Pacific Mwy NB off-ramp (Northbound)															
21b	L3	All MCs	8	0.0	8	0.0	0.252	3.0	LOS A	1.3	9.0	0.18	0.33	0.18	55.4
21a	L1	All MCs	343	1.8	343	1.8	0.252	2.1	LOS A	1.3	9.0	0.18	0.33	0.18	56.0
23a	R1	All MCs	9	11.1	9	11.1	0.252	8.5	LOS A	1.3	9.0	0.18	0.33	0.18	54.6
23b	R3	All MCs	53	2.0	53	2.0	0.252	11.2	LOS B	1.3	9.0	0.18	0.33	0.18	55.0
Approach			414	2.0	414	2.0	0.252	3.4	LOS A	1.3	9.0	0.18	0.33	0.18	55.8
East: Pacific Mwy Overpass (Westbound)															
4	L2	All MCs	1	0.0	1	0.0	0.036	2.5	LOS A	0.1	0.9	0.02	0.49	0.02	54.4
5	T1	All MCs	29	0.0	29	0.0	0.036	2.2	LOS A	0.1	0.9	0.02	0.49	0.02	54.6

6	R2	All MCs	32	0.0	32	0.00.036	9.6	LOS A	0.1	0.9	0.02	0.49	0.02	53.7
6u	U	All MCs	1	0.0	1	0.00.036	12.3	LOS B	0.1	0.9	0.02	0.49	0.02	53.7
Approach			63	0.0	63	0.00.036	6.1	LOS A	0.1	0.9	0.02	0.49	0.02	54.2
West: Gulgan Rd (Southbound)														
10	L2	All MCs	3	0.0	3	0.00.173	2.7	LOS A	0.6	4.2	0.15	0.25	0.15	56.4
11	T1	All MCs	266	4.3	266	4.30.173	2.4	LOS A	0.6	4.2	0.15	0.25	0.15	56.7
12	R2	All MCs	1	0.0	1	0.00.173	9.8	LOS A	0.6	4.2	0.15	0.25	0.15	55.8
12u	U	All MCs	1	0.0	1	0.00.173	12.5	LOS B	0.6	4.2	0.15	0.25	0.15	55.8
Approach			272	4.3	272	4.30.173	2.4	LOS A	0.6	4.2	0.15	0.25	0.15	56.7
All Vehicles			757	2.6	757	2.60.252	3.4	LOS A	1.3	9.0	0.16	0.31	0.16	56.0

MOVEMENT SUMMARY

 Site: 101 [Tyagarah Rbout 2034 PM background (Site Folder: Option A)]

Output produced by SIDRA INTERSECTION Version: 9.1.1.200

New Site
Site Category: (None)
Roundabout

Vehicle Movement Performance

Mov ID	Turn	Mov Class	Demand Flows		Arrival Flows		Deg. Satn	Aver. Delay	Level of Service	95% Back Of Queue		Prop. Que	Eff. Stop Rate	Aver. No. of Cycles	Aver. Speed
			[Total veh/h	[HV %	[Total veh/h	[HV %				[Veh. veh	[Dist] m				
South: Fox lane (Eastbound)															
1	L2	All MCs	5	0.0	5	0.00.017	5.6	LOS A	0.1	0.8	0.69	0.57	0.69	52.1	
2	T1	All MCs	5	0.0	5	0.00.017	5.4	LOS A	0.1	0.8	0.69	0.57	0.69	52.4	
3	R2	All MCs	5	0.0	5	0.00.017	12.8	LOS B	0.1	0.8	0.69	0.57	0.69	51.5	
3u	U	All MCs	1	0.0	1	0.00.017	15.6	LOS B	0.1	0.8	0.69	0.57	0.69	51.5	
Approach			17	0.0	17	0.00.017	8.4	LOS A	0.1	0.8	0.69	0.57	0.69	52.0	
SouthEast: Pacific Mwy NB off-ramp (Northbound)															
21b	L3	All MCs	12	0.0	12	0.00.357	3.1	LOS A	2.0	14.5	0.24	0.34	0.24	55.1	
21a	L1	All MCs	477	1.8	477	1.80.357	2.3	LOS A	2.0	14.5	0.24	0.34	0.24	55.7	
23a	R1	All MCs	14	15.4	14	15.40.357	8.7	LOS A	2.0	14.5	0.24	0.34	0.24	54.2	
23b	R3	All MCs	74	2.9	74	2.90.357	11.3	LOS B	2.0	14.5	0.24	0.34	0.24	54.6	
Approach			576	2.2	576	2.20.357	3.6	LOS A	2.0	14.5	0.24	0.34	0.24	55.5	
East: Pacific Mwy Overpass (Westbound)															
4	L2	All MCs	6	0.0	6	0.00.052	2.5	LOS A	0.2	1.3	0.02	0.48	0.02	54.5	
5	T1	All MCs	40	0.0	40	0.00.052	2.2	LOS A	0.2	1.3	0.02	0.48	0.02	54.8	
6	R2	All MCs	43	0.0	43	0.00.052	9.6	LOS A	0.2	1.3	0.02	0.48	0.02	53.9	
6u	U	All MCs	1	0.0	1	0.00.052	12.3	LOS B	0.2	1.3	0.02	0.48	0.02	53.9	
Approach			91	0.0	91	0.00.052	5.9	LOS A	0.2	1.3	0.02	0.48	0.02	54.3	
West: Gulgan Rd (Southbound)															
10	L2	All MCs	5	0.0	5	0.00.246	2.8	LOS A	0.9	6.7	0.21	0.26	0.21	56.1	
11	T1	All MCs	369	4.3	369	4.30.246	2.5	LOS A	0.9	6.7	0.21	0.26	0.21	56.4	
12	R2	All MCs	2	0.0	2	0.00.246	9.9	LOS A	0.9	6.7	0.21	0.26	0.21	55.4	

12u	U	All MCs	1	0.0	1	0.0	0.246	12.6	LOS B	0.9	6.7	0.21	0.26	0.21	55.4
Approach			378	4.2	378	4.2	0.246	2.6	LOS A	0.9	6.7	0.21	0.26	0.21	56.4
All Vehicles			1061	2.7	1061	2.7	0.357	3.5	LOS A	2.0	14.5	0.22	0.33	0.22	55.6

MOVEMENT SUMMARY

 Site: 101 [Tyagarah Rbout 2034 PM development (Site Folder: Option A)]

Output produced by SIDRA INTERSECTION Version: 9.1.1.200

New Site
Site Category: (None)
Roundabout

Vehicle Movement Performance

Mov ID	Turn	Mov Class	Demand Flows		Arrival Flows		Deg. Satn	Aver. Delay	Level of Service	95% Back Of Queue		Prop. Que	Eff. Stop Rate	Aver. No. of Cycles	Aver. Speed
			[Total]	[HV]	[Total]	[HV]				[Veh.]	[Dist]				
			veh/h	%	veh/h	%	v/c	sec			veh	m			km/h
South: Fox lane (Eastbound)															
1	L2	All MCs	5	0.0	5	0.0	0.014	6.0	LOS A	0.1	0.7	0.72	0.58	0.72	51.7
2	T1	All MCs	2	0.0	2	0.0	0.014	5.8	LOS A	0.1	0.7	0.72	0.58	0.72	51.9
3	R2	All MCs	5	0.0	5	0.0	0.014	13.3	LOS B	0.1	0.7	0.72	0.58	0.72	51.1
3u	U	All MCs	1	0.0	1	0.0	0.014	16.0	LOS B	0.1	0.7	0.72	0.58	0.72	51.1
Approach			14	0.0	14	0.0	0.014	9.5	LOS A	0.1	0.7	0.72	0.58	0.72	51.4
SouthEast: Pacific Mwy NB off-ramp (Northbound)															
21b	L3	All MCs	12	0.0	12	0.0	0.392	3.1	LOS A	2.3	16.6	0.25	0.33	0.25	55.2
21a	L1	All MCs	533	2.6	533	2.6	0.392	2.3	LOS A	2.3	16.6	0.25	0.33	0.25	55.7
23a	R1	All MCs	14	15.4	14	15.4	0.392	8.7	LOS A	2.3	16.6	0.25	0.33	0.25	54.2
23b	R3	All MCs	74	2.9	74	2.9	0.392	11.4	LOS B	2.3	16.6	0.25	0.33	0.25	54.7
Approach			632	2.8	632	2.8	0.392	3.5	LOS A	2.3	16.6	0.25	0.33	0.25	55.5
East: Pacific Mwy Overpass (Westbound)															
4	L2	All MCs	6	0.0	6	0.0	0.052	2.5	LOS A	0.2	1.3	0.02	0.48	0.02	54.5
5	T1	All MCs	40	0.0	40	0.0	0.052	2.2	LOS A	0.2	1.3	0.02	0.48	0.02	54.8
6	R2	All MCs	43	0.0	43	0.0	0.052	9.6	LOS A	0.2	1.3	0.02	0.48	0.02	53.9
6u	U	All MCs	1	0.0	1	0.0	0.052	12.3	LOS B	0.2	1.3	0.02	0.48	0.02	53.9
Approach			91	0.0	91	0.0	0.052	5.9	LOS A	0.2	1.3	0.02	0.48	0.02	54.3
West: Gulgan Rd (Southbound)															
10	L2	All MCs	5	0.0	5	0.0	0.245	2.8	LOS A	0.9	6.7	0.21	0.26	0.21	56.1
11	T1	All MCs	369	4.3	369	4.3	0.245	2.5	LOS A	0.9	6.7	0.21	0.26	0.21	56.4
12	R2	All MCs	2	0.0	2	0.0	0.245	9.9	LOS A	0.9	6.7	0.21	0.26	0.21	55.4
12u	U	All MCs	1	0.0	1	0.0	0.245	12.6	LOS B	0.9	6.7	0.21	0.26	0.21	55.4
Approach			378	4.2	378	4.2	0.245	2.6	LOS A	0.9	6.7	0.21	0.26	0.21	56.4
All Vehicles			1114	3.0	1114	3.0	0.392	3.4	LOS A	2.3	16.6	0.22	0.32	0.22	55.7

APPENDIX H – SIDRA OUTPUT OPTION B

MOVEMENT SUMMARY

 **Site: 101 [Access Road RB 2034 AM (Site Folder: Option B)]**

Output produced by SIDRA INTERSECTION Version: 9.1.1.200

New Site
Site Category: (None)
Roundabout

Vehicle Movement Performance															
Mov ID	Turn	Mov Class	Demand Flows		Arrival Flows		Deg. Satn	Aver. Delay	Level of Service	95% Back Of Queue		Prop. Que	Eff. Stop Rate	Aver. No. of Cycles	Aver. Speed
			[Total veh/h]	[HV %]	[Total veh/h]	[HV %]				[Veh. veh]	[Dist m]				
South: Gulgan Road South															
1	L2	All MCs	43	9.8	43	9.8	0.546	5.6	LOS A	4.2	31.4	0.58	0.52	0.58	52.3
2	T1	All MCs	622	6.3	622	6.3	0.546	5.7	LOS A	4.2	31.4	0.58	0.52	0.58	52.7
Approach			665	6.5	665	6.5	0.546	5.6	LOS A	4.2	31.4	0.58	0.52	0.58	52.7
North: Gulgan Road North															
8	T1	All MCs	778	2.4	778	2.4	0.391	3.9	LOS A	0.0	0.0	0.00	0.38	0.00	55.4
9	R2	All MCs	229	10.1	229	10.1	0.138	9.1	LOS A	0.9	6.7	0.15	0.59	0.15	50.3
Approach			1007	4.2	1007	4.2	0.391	5.1	LOS A	0.9	6.7	0.03	0.43	0.03	54.1
West: Proposed Access															
10	L2	All MCs	153	10.3	153	10.3	0.154	6.9	LOS A	1.1	8.1	0.72	0.64	0.72	52.2
12	R2	All MCs	29	10.7	29	10.7	0.044	15.1	LOS B	0.2	1.9	0.69	0.72	0.69	48.2
Approach			182	10.4	182	10.4	0.154	8.2	LOS A	1.1	8.1	0.71	0.65	0.71	51.5
All Vehicles			1855	5.6	1855	5.6	0.546	5.6	LOS A	4.2	31.4	0.30	0.48	0.30	53.4

MOVEMENT SUMMARY

 **Site: 101 [Access Road RB 2044 AM (Site Folder: Option B)]**

Output produced by SIDRA INTERSECTION Version: 9.1.1.200

New Site
Site Category: (None)
Roundabout

Vehicle Movement Performance															
Mov ID	Turn	Mov Class	Demand Flows		Arrival Flows		Deg. Satn	Aver. Delay	Level of Service	95% Back Of Queue		Prop. Que	Eff. Stop Rate	Aver. No. of Cycles	Aver. Speed
			[Total veh/h]	[HV %]	[Total veh/h]	[HV %]				[Veh. veh]	[Dist m]				
South: Gulgan Road South															
1	L2	All MCs	43	9.8	43	9.8	0.735	7.3	LOS A	8.9	65.6	0.75	0.62	0.82	51.5
2	T1	All MCs	864	6.2	864	6.2	0.735	7.3	LOS A	8.9	65.6	0.75	0.62	0.82	52.0
Approach			907	6.4	907	6.4	0.735	7.3	LOS A	8.9	65.6	0.75	0.62	0.82	52.0

North: Gulgan Road North															
8	T1	All MCs	1083	2.5	1083	2.5	0.545	4.0	LOS A	0.0	0.0	0.00	0.38	0.00	55.3
9	R2	All MCs	229	10.1	229	10.1	0.138	9.1	LOS A	0.9	7.0	0.15	0.59	0.15	50.2
Approach			1313	3.8	1313	3.8	0.545	4.9	LOS A	0.9	7.0	0.03	0.41	0.03	54.3
West: Proposed Access															
10	L2	All MCs	153	10.3	153	10.3	0.215	9.1	LOS A	1.7	13.2	0.92	0.73	0.92	50.7
12	R2	All MCs	29	10.7	29	10.7	0.060	19.7	LOS B	0.4	2.9	0.85	0.78	0.85	46.8
Approach			182	10.4	182	10.4	0.215	10.8	LOS B	1.7	13.2	0.91	0.74	0.91	50.0
All Vehicles			2402	5.3	2402	5.3	0.735	6.3	LOS A	8.9	65.6	0.37	0.52	0.39	53.1

MOVEMENT SUMMARY

 **Site: 101 [Access Road RB 2034 PM (Site Folder: Option B)]**

Output produced by SIDRA INTERSECTION Version: 9.1.1.200

New Site
Site Category: (None)
Roundabout

Vehicle Movement Performance															
Mov ID	Turn	Mov Class	Demand Flows		Arrival Flows		Deg. Satn	Aver. Delay	Level of Service	95% Back Of Queue		Prop. Que	Eff. Stop Rate	Aver. No. of Cycles	Aver. Speed
			[Total veh/h]	[HV %]	[Total veh/h]	[HV %]				[Veh. veh]	[Dist m]				
South: Gulgan Road South															
1	L2	All MCs	25	12.5	25	12.5	0.579	5.0	LOS A	5.1	36.2	0.48	0.45	0.48	52.6
2	T1	All MCs	780	2.3	780	2.3	0.579	4.9	LOS A	5.1	36.2	0.48	0.45	0.48	53.3
Approach			805	2.6	805	2.6	0.579	4.9	LOS A	5.1	36.2	0.48	0.45	0.48	53.2
North: Gulgan Road North															
8	T1	All MCs	554	2.9	554	2.9	0.279	3.9	LOS A	0.0	0.0	0.00	0.38	0.00	55.5
9	R2	All MCs	133	10.3	133	10.3	0.083	9.2	LOS A	0.5	3.9	0.19	0.59	0.19	50.1
Approach			686	4.3	686	4.3	0.279	4.9	LOS A	0.5	3.9	0.04	0.42	0.04	54.3
West: Proposed Access															
10	L2	All MCs	191	6.6	191	6.6	0.210	8.0	LOS A	1.6	11.5	0.81	0.68	0.81	51.6
12	R2	All MCs	46	27.3	46	27.3	0.087	16.8	LOS B	0.5	4.2	0.76	0.77	0.76	46.4
Approach			237	10.7	237	10.7	0.210	9.8	LOS A	1.6	11.5	0.80	0.70	0.80	50.5
All Vehicles			1728	4.4	1728	4.4	0.579	5.6	LOS A	5.1	36.2	0.35	0.47	0.35	53.3

MOVEMENT SUMMARY

 **Site: 101 [Access Road RB 2044 PM (Site Folder: Option B)]**

Output produced by SIDRA INTERSECTION Version: 9.1.1.200

New Site
Site Category: (None)
Roundabout

Vehicle Movement Performance

Mov ID	Turn	Mov Class	Demand Flows		Arrival Flows		Deg. Satn	Aver. Delay	Level of Service	95% Back Of Queue		Prop. Que	Eff. Stop Rate	Aver. No. of Cycles	Aver. Speed
			[Total veh/h]	[HV %]	[Total veh/h]	[HV %]				[Veh. veh]	[Dist m]				
South: Gulgan Road South															
1	L2	All MCs	25	12.5	25	12.5	0.787	5.6	LOS A	10.1	72.5	0.69	0.51	0.69	51.7
2	T1	All MCs	1084	2.2	1084	2.2	0.787	5.5	LOS A	10.1	72.5	0.69	0.51	0.69	52.3
Approach			1109	2.5	1109	2.5	0.787	5.5	LOS A	10.1	72.5	0.69	0.51	0.69	52.3
North: Gulgan Road North															
8	T1	All MCs	771	2.9	771	2.9	0.388	3.9	LOS A	0.0	0.0	0.00	0.38	0.00	55.4
9	R2	All MCs	133	10.3	133	10.3	0.084	9.2	LOS A	0.5	4.1	0.20	0.58	0.20	50.1
Approach			903	4.0	903	4.0	0.388	4.7	LOS A	0.5	4.1	0.03	0.41	0.03	54.5
West: Proposed Access															
10	L2	All MCs	191	6.6	191	6.6	0.335	12.3	LOS B	3.0	22.0	1.00	0.80	1.00	48.7
12	R2	All MCs	46	27.3	46	27.3	0.132	22.6	LOS C	0.9	7.5	0.93	0.83	0.93	43.9
Approach			237	10.7	237	10.7	0.335	14.3	LOS B	3.0	22.0	0.99	0.81	0.99	47.6
All Vehicles			2249	3.9	2249	3.9	0.787	6.1	LOS A	10.1	72.5	0.46	0.50	0.46	52.6

MOVEMENT SUMMARY

 **Site: 101 [Bruns Rbout 2024 AM background (Site Folder: Option B)]**

Output produced by SIDRA INTERSECTION Version: 9.1.1.200

New Site
Site Category: (None)
Roundabout

Vehicle Movement Performance

Mov ID	Turn	Mov Class	Demand Flows		Arrival Flows		Deg. Satn	Aver. Delay	Level of Service	95% Back Of Queue		Prop. Que	Eff. Stop Rate	Aver. No. of Cycles	Aver. Speed
			[Total veh/h]	[HV %]	[Total veh/h]	[HV %]				[Veh. veh]	[Dist m]				
South: Gulgan Road															
1	L2	All MCs	1	100.0	1	100.0	0.319	5.6	LOS A	2.3	16.9	0.41	0.50	0.41	49.9
2	T1	All MCs	229	4.4	229	4.4	0.319	4.0	LOS A	2.3	16.9	0.41	0.50	0.41	52.7
3	R2	All MCs	191	6.3	191	6.3	0.319	10.1	LOS B	2.3	16.9	0.41	0.50	0.41	51.7
3u	U	All MCs	1	0.0	1	0.0	0.319	12.4	LOS B	2.3	16.9	0.41	0.50	0.41	51.9
Approach			422	5.5	422	5.5	0.319	6.8	LOS A	2.3	16.9	0.41	0.50	0.41	52.2
East: Pacific Mwy															
4	L2	All MCs	1	0.0	1	0.0	0.136	5.8	LOS A	0.9	6.2	0.65	0.68	0.65	49.6
5	T1	All MCs	1	0.0	1	0.0	0.136	5.7	LOS A	0.9	6.2	0.65	0.68	0.65	49.9
6	R2	All MCs	131	3.1	131	3.1	0.136	11.9	LOS B	0.9	6.2	0.65	0.68	0.65	49.0
6u	U	All MCs	1	0.0	1	0.0	0.136	14.2	LOS B	0.9	6.2	0.65	0.68	0.65	49.1
Approach			134	3.0	134	3.0	0.136	11.8	LOS B	0.9	6.2	0.65	0.68	0.65	49.0
North: Tweed Street															
7	L2	All MCs	30	0.0	30	0.0	0.445	4.6	LOS A	3.4	24.3	0.52	0.46	0.52	53.3
8	T1	All MCs	527	2.1	527	2.1	0.445	4.6	LOS A	3.4	24.3	0.52	0.46	0.52	53.7
9	R2	All MCs	1	0.0	1	0.0	0.445	10.6	LOS B	3.4	24.3	0.52	0.46	0.52	52.7

9u	U	All MCs	2	0.0	2	0.0	0.445	13.0	LOS B	3.4	24.3	0.52	0.46	0.52	52.7
Approach			560	2.0	560	2.0	0.445	4.6	LOS A	3.4	24.3	0.52	0.46	0.52	53.6
West: Saddle Road															
10	L2	All MCs	4	0.0	4	0.0	0.011	2.4	LOS A	0.1	0.5	0.61	0.38	0.61	10.5
11	T1	All MCs	1	0.0	1	0.0	0.011	2.4	LOS A	0.1	0.5	0.61	0.38	0.61	10.5
12	R2	All MCs	4	50.0	4	50.0	0.011	3.5	LOS A	0.1	0.5	0.61	0.38	0.61	10.5
12u	U	All MCs	1	0.0	1	0.0	0.011	14.0	LOS B	0.1	0.5	0.61	0.38	0.61	17.8
Approach			10	20.0	10	20.0	0.011	4.0	LOS A	0.1	0.5	0.61	0.38	0.61	10.9
All Vehicles			1126	3.6	1126	3.6	0.445	6.3	LOS A	3.4	24.3	0.50	0.50	0.50	50.8

MOVEMENT SUMMARY

 **Site: 101 [Bruns Rbout 2034 AM background (Site Folder: Option B)]**

Output produced by SIDRA INTERSECTION Version: 9.1.1.200

New Site
Site Category: (None)
Roundabout

Vehicle Movement Performance

Mov ID	Turn	Mov Class	Demand Flows		Arrival Flows		Deg. Satn	Aver. Delay	Level of Service	95% Back Of Queue		Prop. Que	Eff. Stop Rate	Aver. No. of Cycles	Aver. Speed
			[Total veh/h	[HV %	[Total veh/h	[HV %				[Veh. veh	[Dist] m				
South: Gulgan Road															
1	L2	All MCs	1	100.0	1	100.0	0.476	6.7	LOS A	4.1	30.4	0.57	0.54	0.57	49.4
2	T1	All MCs	318	4.4	318	4.4	0.476	4.5	LOS A	4.1	30.4	0.57	0.54	0.57	52.1
3	R2	All MCs	270	7.8	270	7.8	0.476	10.6	LOS B	4.1	30.4	0.57	0.54	0.57	51.0
3u	U	All MCs	2	0.0	2	0.0	0.476	12.9	LOS B	4.1	30.4	0.57	0.54	0.57	51.3
Approach			591	6.1	591	6.1	0.476	7.3	LOS A	4.1	30.4	0.57	0.54	0.57	51.6
East: Pacific Mwy															
4	L2	All MCs	1	0.0	1	0.0	0.248	7.6	LOS A	1.9	13.6	0.86	0.74	0.86	48.8
5	T1	All MCs	1	0.0	1	0.0	0.248	7.5	LOS A	1.9	13.6	0.86	0.74	0.86	49.1
6	R2	All MCs	182	3.3	182	3.3	0.248	13.7	LOS B	1.9	13.6	0.86	0.74	0.86	48.2
6u	U	All MCs	1	0.0	1	0.0	0.248	16.0	LOS B	1.9	13.6	0.86	0.74	0.86	48.3
Approach			185	3.2	185	3.2	0.248	13.7	LOS B	1.9	13.6	0.86	0.74	0.86	48.2
North: Tweed Street															
7	L2	All MCs	41	0.0	41	0.0	0.673	6.7	LOS A	7.6	54.0	0.79	0.63	0.86	52.1
8	T1	All MCs	732	2.0	732	2.0	0.673	6.7	LOS A	7.6	54.0	0.79	0.63	0.86	52.4
9	R2	All MCs	1	0.0	1	0.0	0.673	12.6	LOS B	7.6	54.0	0.79	0.63	0.86	51.5
9u	U	All MCs	3	0.0	3	0.0	0.673	15.0	LOS B	7.6	54.0	0.79	0.63	0.86	51.5
Approach			777	1.9	777	1.9	0.673	6.7	LOS A	7.6	54.0	0.79	0.63	0.86	52.4
West: Saddle Road															
10	L2	All MCs	6	0.0	6	0.0	0.022	4.1	LOS A	0.1	1.1	0.75	0.52	0.75	10.2
11	T1	All MCs	2	0.0	2	0.0	0.022	4.1	LOS A	0.1	1.1	0.75	0.52	0.75	10.2
12	R2	All MCs	6	50.0	6	50.0	0.022	5.7	LOS A	0.1	1.1	0.75	0.52	0.75	10.2
12u	U	All MCs	1	0.0	1	0.0	0.022	15.7	LOS B	0.1	1.1	0.75	0.52	0.75	17.1

Approach	15	20.0	15	20.0	0.022	5.5	LOS A	0.1	1.1	0.75	0.52	0.75	10.5
All Vehicles	1568	3.8	1568	3.8	0.673	7.8	LOS A	7.6	54.0	0.71	0.61	0.75	49.7

MOVEMENT SUMMARY

 Site: 101 [Bruns Rbout 2034 AM development (Site Folder: Option B)]

Output produced by SIDRA INTERSECTION Version: 9.1.1.200

New Site
Site Category: (None)
Roundabout

Vehicle Movement Performance

Mov ID	Turn	Mov Class	Demand Flows		Arrival Flows		Deg. Satn	Aver. Delay	Level of Service	95% Back Of Queue		Prop. Que	Eff. Stop Rate	Aver. No. of Cycles	Aver. Speed
			[Total veh/h	HV] %	[Total veh/h	HV] %				[Veh. veh	Dist] m				
South: Gulgan Road															
1	L2	All MCs	2	100.0	2	100.0	0.547	6.9	LOS A	5.3	39.1	0.64	0.54	0.64	49.2
2	T1	All MCs	366	5.2	366	5.2	0.547	4.7	LOS A	5.3	39.1	0.64	0.54	0.64	51.9
3	R2	All MCs	305	8.2	305	8.2	0.547	10.8	LOS B	5.3	39.1	0.64	0.54	0.64	50.8
3u	U	All MCs	2	0.0	2	0.0	0.547	13.0	LOS B	5.3	39.1	0.64	0.54	0.64	51.1
Approach			675	6.8	675	6.8	0.547	7.5	LOS A	5.3	39.1	0.64	0.54	0.64	51.4
East: Pacific Mwy															
4	L2	All MCs	93	10.8	93	10.8	0.494	12.1	LOS B	4.7	34.5	1.00	0.87	1.13	47.1
5	T1	All MCs	1	0.0	1	0.0	0.494	11.5	LOS B	4.7	34.5	1.00	0.87	1.13	47.6
6	R2	All MCs	182	3.3	182	3.3	0.494	17.7	LOS B	4.7	34.5	1.00	0.87	1.13	46.7
6u	U	All MCs	1	0.0	1	0.0	0.494	19.9	LOS B	4.7	34.5	1.00	0.87	1.13	46.8
Approach			277	5.8	277	5.8	0.494	15.8	LOS B	4.7	34.5	1.00	0.87	1.13	46.9
North: Tweed Street															
7	L2	All MCs	41	0.0	41	0.0	0.818	10.8	LOS B	14.3	102.9	0.98	0.86	1.28	50.3
8	T1	All MCs	858	3.4	858	3.4	0.818	10.9	LOS B	14.3	102.9	0.98	0.86	1.28	50.6
9	R2	All MCs	1	0.0	1	0.0	0.818	16.8	LOS B	14.3	102.9	0.98	0.86	1.28	49.8
9u	U	All MCs	3	0.0	3	0.0	0.818	19.2	LOS B	14.3	102.9	0.98	0.86	1.28	49.8
Approach			903	3.2	903	3.2	0.818	10.9	LOS B	14.3	102.9	0.98	0.86	1.28	50.5
West: Saddle Road															
10	L2	All MCs	6	0.0	6	0.0	0.025	5.0	LOS A	0.2	1.3	0.81	0.58	0.81	10.2
11	T1	All MCs	2	0.0	2	0.0	0.025	5.0	LOS A	0.2	1.3	0.81	0.58	0.81	10.2
12	R2	All MCs	6	50.0	6	50.0	0.025	6.8	LOS A	0.2	1.3	0.81	0.58	0.81	10.2
12u	U	All MCs	1	0.0	1	0.0	0.025	16.6	LOS B	0.2	1.3	0.81	0.58	0.81	17.0
Approach			15	20.0	15	20.0	0.025	6.5	LOS A	0.2	1.3	0.81	0.58	0.81	10.5
All Vehicles			1870	5.0	1870	5.0	0.818	10.4	LOS B	14.3	102.9	0.86	0.74	1.02	48.8

MOVEMENT SUMMARY

 Site: 101 [Bruns Rbout 2024 PM background (Site Folder: Option B)]

Output produced by SIDRA INTERSECTION Version: 9.1.1.200

New Site
Site Category: (None)
Roundabout

Vehicle Movement Performance															
Mov ID	Turn	Mov Class	Demand Flows		Arrival Flows		Deg. Satn	Aver. Delay	Level of Service	95% Back Of Queue		Prop. Que	Eff. Stop Rate	Aver. No. of Cycles	Aver. Speed
			[Total]	[HV]	[Total]	[HV]				[Veh.]	[Dist]				
			veh/h	%	veh/h	%	v/c	sec		veh	m				
South: Gulgan Road															
1	L2	All MCs	1	0.0	1	0.0	0.409	4.3	LOS A	3.2	22.6	0.49	0.54	0.49	51.8
2	T1	All MCs	243	3.7	243	3.7	0.409	4.3	LOS A	3.2	22.6	0.49	0.54	0.49	52.1
3	R2	All MCs	288	1.0	288	1.0	0.409	10.3	LOS B	3.2	22.6	0.49	0.54	0.49	51.2
3u	U	All MCs	1	0.0	1	0.0	0.409	12.7	LOS B	3.2	22.6	0.49	0.54	0.49	51.3
Approach			533	2.3	533	2.3	0.409	7.6	LOS A	3.2	22.6	0.49	0.54	0.49	51.6
East: Pacific Mwy															
4	L2	All MCs	2	0.0	2	0.0	0.157	5.0	LOS A	1.0	7.1	0.57	0.65	0.57	49.9
5	T1	All MCs	1	0.0	1	0.0	0.157	4.9	LOS A	1.0	7.1	0.57	0.65	0.57	50.2
6	R2	All MCs	167	4.2	167	4.2	0.157	11.1	LOS B	1.0	7.1	0.57	0.65	0.57	49.2
6u	U	All MCs	3	0.0	3	0.0	0.157	13.4	LOS B	1.0	7.1	0.57	0.65	0.57	49.4
Approach			173	4.0	173	4.0	0.157	11.0	LOS B	1.0	7.1	0.57	0.65	0.57	49.2
North: Tweed Street															
7	L2	All MCs	50	8.0	50	8.0	0.384	5.3	LOS A	2.7	19.7	0.59	0.51	0.59	52.9
8	T1	All MCs	375	2.9	375	2.9	0.384	5.1	LOS A	2.7	19.7	0.59	0.51	0.59	53.3
9	R2	All MCs	1	0.0	1	0.0	0.384	11.0	LOS B	2.7	19.7	0.59	0.51	0.59	52.4
9u	U	All MCs	3	0.0	3	0.0	0.384	13.5	LOS B	2.7	19.7	0.59	0.51	0.59	52.4
Approach			429	3.5	429	3.5	0.384	5.2	LOS A	2.7	19.7	0.59	0.51	0.59	53.3
West: Saddle Road															
10	L2	All MCs	3	0.0	3	0.0	0.008	3.3	LOS A	0.0	0.3	0.69	0.43	0.69	10.6
11	T1	All MCs	2	0.0	2	0.0	0.008	3.3	LOS A	0.0	0.3	0.69	0.43	0.69	10.6
12	R2	All MCs	1	0.0	1	0.0	0.008	3.3	LOS A	0.0	0.3	0.69	0.43	0.69	10.6
12u	U	All MCs	1	0.0	1	0.0	0.008	15.0	LOS B	0.0	0.3	0.69	0.43	0.69	18.0
Approach			7	0.0	7	0.0	0.008	5.0	LOS A	0.0	0.3	0.69	0.43	0.69	11.2
All Vehicles			1142	3.0	1142	3.0	0.409	7.2	LOS A	3.2	22.6	0.54	0.55	0.54	50.7

MOVEMENT SUMMARY

 **Site: 101 [Bruns Rbout 2034 PM background (Site Folder: Option B)]**

Output produced by SIDRA INTERSECTION Version: 9.1.1.200

New Site
Site Category: (None)
Roundabout

Vehicle Movement Performance															
Mov ID	Turn	Mov Class	Demand Flows		Arrival Flows		Deg. Satn	Aver. Delay	Level of Service	95% Back Of Queue		Prop. Que	Eff. Stop Rate	Aver. No. of Cycles	Aver. Speed
			[Total]	[HV]	[Total]	[HV]				[Veh.]	[Dist]				
			veh/h	%	veh/h	%	v/c	sec		veh	m				

South: Gulgan Road															
1	L2	All MCs	2	0.0	2	0.0	0.614	5.2	LOS A	5.9	42.4	0.72	0.60	0.72	51.1
2	T1	All MCs	337	3.6	337	3.6	0.614	5.2	LOS A	5.9	42.4	0.72	0.60	0.72	51.3
3	R2	All MCs	401	1.2	401	1.2	0.614	11.2	LOS B	5.9	42.4	0.72	0.60	0.72	50.5
3u	U	All MCs	2	0.0	2	0.0	0.614	13.6	LOS B	5.9	42.4	0.72	0.60	0.72	50.5
Approach			742	2.3	742	2.3	0.614	8.5	LOS A	5.9	42.4	0.72	0.60	0.72	50.9
East: Pacific Mwy															
4	L2	All MCs	3	0.0	3	0.0	0.260	6.0	LOS A	1.9	13.6	0.74	0.69	0.74	49.3
5	T1	All MCs	2	0.0	2	0.0	0.260	6.0	LOS A	1.9	13.6	0.74	0.69	0.74	49.6
6	R2	All MCs	232	3.9	232	3.9	0.260	12.1	LOS B	1.9	13.6	0.74	0.69	0.74	48.7
6u	U	All MCs	5	0.0	5	0.0	0.260	14.4	LOS B	1.9	13.6	0.74	0.69	0.74	48.8
Approach			242	3.7	242	3.7	0.260	12.1	LOS B	1.9	13.6	0.74	0.69	0.74	48.7
North: Tweed Street															
7	L2	All MCs	70	8.6	70	8.6	0.609	8.0	LOS A	6.2	44.8	0.83	0.71	0.94	51.6
8	T1	All MCs	521	2.9	521	2.9	0.609	7.7	LOS A	6.2	44.8	0.83	0.71	0.94	52.1
9	R2	All MCs	2	0.0	2	0.0	0.609	13.6	LOS B	6.2	44.8	0.83	0.71	0.94	51.2
9u	U	All MCs	5	0.0	5	0.0	0.609	16.0	LOS B	6.2	44.8	0.83	0.71	0.94	51.2
Approach			598	3.5	598	3.5	0.609	7.8	LOS A	6.2	44.8	0.83	0.71	0.94	52.0
West: Saddle Road															
10	L2	All MCs	5	0.0	5	0.0	0.021	6.3	LOS A	0.2	1.1	0.88	0.61	0.88	10.2
11	T1	All MCs	6	0.0	6	0.0	0.021	6.3	LOS A	0.2	1.1	0.88	0.61	0.88	10.2
12	R2	All MCs	1	0.0	1	0.0	0.021	6.3	LOS A	0.2	1.1	0.88	0.61	0.88	10.2
12u	U	All MCs	1	0.0	1	0.0	0.021	18.0	LOS B	0.2	1.1	0.88	0.61	0.88	16.9
Approach			13	0.0	13	0.0	0.021	7.2	LOS A	0.2	1.1	0.88	0.61	0.88	10.5
All Vehicles			1595	2.9	1595	2.9	0.614	8.8	LOS A	6.2	44.8	0.77	0.65	0.81	49.4

MOVEMENT SUMMARY

 Site: 101 [Bruns Rbout 2034 PM background (Site Folder: Option B)]

Output produced by SIDRA INTERSECTION Version: 9.1.1.200

New Site
Site Category: (None)
Roundabout

Vehicle Movement Performance

Mov ID	Turn	Mov Class	Demand Flows		Arrival Flows		Deg. Satn	Aver. Delay	Level of Service	95% Back Of Queue		Prop. Que	Eff. Stop Rate	Aver. No. of Cycles	Aver. Speed
			[Total]	[HV]	[Total]	[HV]				[Veh.]	[Dist]				
			veh/h	%	veh/h	%	v/c	sec		veh	m				km/h
South: Gulgan Road															
1	L2	All MCs	2	0.0	2	0.0	0.711	6.4	LOS A	9.0	64.8	0.82	0.66	0.89	50.6
2	T1	All MCs	400	4.8	400	4.8	0.711	6.5	LOS A	9.0	64.8	0.82	0.66	0.89	50.8
3	R2	All MCs	446	2.0	446	2.0	0.711	12.4	LOS B	9.0	64.8	0.82	0.66	0.89	50.0
3u	U	All MCs	2	0.0	2	0.0	0.711	14.8	LOS B	9.0	64.8	0.82	0.66	0.89	50.0
Approach			850	3.3	850	3.3	0.711	9.6	LOS A	9.0	64.8	0.82	0.66	0.89	50.4
East: Pacific Mwy															

4	L2	All MCs	51	0.0	51	0.00.350	6.7	LOS A	2.8	20.0	0.84	0.71	0.84	49.8
5	T1	All MCs	6	0.0	6	0.00.350	6.7	LOS A	2.8	20.0	0.84	0.71	0.84	50.1
6	R2	All MCs	232	3.9	232	3.90.350	12.9	LOS B	2.8	20.0	0.84	0.71	0.84	49.2
6u	U	All MCs	5	0.0	5	0.00.350	15.1	LOS B	2.8	20.0	0.84	0.71	0.84	49.3
Approach			294	3.1	294	3.10.350	11.7	LOS B	2.8	20.0	0.84	0.71	0.84	49.3
North: Tweed Street														
7	L2	All MCs	70	8.6	70	8.60.728	11.1	LOS B	9.7	70.7	0.96	0.86	1.25	50.1
8	T1	All MCs	594	3.9	594	3.90.728	10.9	LOS B	9.7	70.7	0.96	0.86	1.25	50.5
9	R2	All MCs	2	0.0	2	0.00.728	16.7	LOS B	9.7	70.7	0.96	0.86	1.25	49.7
9u	U	All MCs	5	0.0	5	0.00.728	19.1	LOS B	9.7	70.7	0.96	0.86	1.25	49.7
Approach			671	4.3	671	4.30.728	11.0	LOS B	9.7	70.7	0.96	0.86	1.25	50.5
West: Saddle Road														
10	L2	All MCs	5	0.0	5	0.00.026	8.3	LOS A	0.2	1.4	0.96	0.69	0.96	10.1
11	T1	All MCs	6	0.0	6	0.00.026	8.3	LOS A	0.2	1.4	0.96	0.69	0.96	10.1
12	R2	All MCs	1	0.0	1	0.00.026	8.3	LOS A	0.2	1.4	0.96	0.69	0.96	10.1
12u	U	All MCs	1	0.0	1	0.00.026	19.9	LOS B	0.2	1.4	0.96	0.69	0.96	16.8
Approach			13	0.0	13	0.00.026	9.2	LOS A	0.2	1.4	0.96	0.69	0.96	10.4
All Vehicles			1828	3.6	1828	3.60.728	10.5	LOS B	9.7	70.7	0.88	0.74	1.01	48.9

MOVEMENT SUMMARY

▽ Site: 101 [Tandys 2024 AM background (Site Folder: Option B)]

Output produced by SIDRA INTERSECTION Version: 9.1.1.200

New Site
Site Category: (None)
Give-Way (Two-Way)

Vehicle Movement Performance

Mov ID	Turn	Mov Class	Demand Flows		Arrival Flows		Deg. Satn	Aver. Delay	Level of Service	95% Back Of Queue		Prop. Que	Eff. Stop Rate	Aver. No. of Cycles	Aver. Speed
			[Total]	[HV]	[Total]	[HV]				[Veh.]	[Dist]				
			veh/h	%	veh/h	%	v/c	sec			veh	m			km/h
South: Gulgan Road (S)															
2	T1	All MCs	433	5.8	433	5.8	0.282	0.0	LOS A	0.6	4.5	0.14	0.16	0.14	77.1
3	R2	All MCs	16	6.7	16	6.7	0.282	20.5	LOS B	0.6	4.5	0.14	0.16	0.14	68.3
3u	U	All MCs	14	0.0	14	0.0	0.282	26.7	LOS B	0.6	4.5	0.14	0.16	0.14	62.8
Approach			462	5.7	462	5.7	0.282	1.5	NA	0.6	4.5	0.14	0.16	0.14	76.2
East: Tandys Lane															
4	L2	All MCs	20	5.3	20	5.3	0.046	9.6	LOS A	0.2	1.2	0.60	0.77	0.60	58.1
6	R2	All MCs	6	0.0	6	0.0	0.046	18.7	LOS B	0.2	1.2	0.60	0.77	0.60	59.5
Approach			26	4.0	26	4.0	0.046	11.8	LOS A	0.2	1.2	0.60	0.77	0.60	58.4
North: Gulgan Road (N)															
7	L2	All MCs	4	0.0	4	0.0	0.002	6.9	LOS A	0.0	0.0	0.00	0.63	0.00	64.6
8	T1	All MCs	567	3.3	567	3.3	0.297	0.1	LOS A	0.0	0.0	0.00	0.00	0.00	79.8
Approach			572	3.3	572	3.3	0.297	0.1	NA	0.0	0.0	0.00	0.00	0.00	79.7
All Vehicles			1060	4.4	1060	4.4	0.297	1.0	NA	0.6	4.5	0.08	0.09	0.08	77.4

MOVEMENT SUMMARY

▽ Site: 101 [Tandys 2034 AM background (Site Folder: Option B)]

Output produced by SIDRA INTERSECTION Version: 9.1.1.200

New Site
Site Category: (None)
Give-Way (Two-Way)

Vehicle Movement Performance															
Mov ID	Turn	Mov Class	Demand Flows		Arrival Flows		Deg. Satn	Aver. Delay	Level of Service	95% Back Of Queue		Prop. Que	Eff. Stop Rate	Aver. No. of Cycles	Aver. Speed
			[Total veh/h]	[HV %]	[Total veh/h]	[HV %]				[Veh. veh]	[Dist m]				
South: Gulgan Road (S)															
2	T1	All MCs	603	5.9	603	5.9	0.436	0.8	LOS A	2.2	16.5	0.20	0.24	0.28	73.4
3	R2	All MCs	23	9.1	23	9.1	0.436	40.6	LOS C	2.2	16.5	0.20	0.24	0.28	64.6
3u	U	All MCs	19	0.0	19	0.0	0.436	56.4	LOS D	2.2	16.5	0.20	0.24	0.28	60.3
Approach			645	5.9	645	5.9	0.436	3.9	NA	2.2	16.5	0.20	0.24	0.28	72.6
East: Tandys Lane															
4	L2	All MCs	28	7.4	28	7.4	0.117	12.0	LOS A	0.4	2.7	0.77	0.91	0.77	52.7
6	R2	All MCs	8	0.0	8	0.0	0.117	36.9	LOS C	0.4	2.7	0.77	0.91	0.77	54.3
Approach			37	5.7	37	5.7	0.117	17.7	LOS B	0.4	2.7	0.77	0.91	0.77	53.1
North: Gulgan Road (N)															
7	L2	All MCs	6	0.0	6	0.0	0.003	6.9	LOS A	0.0	0.0	0.00	0.63	0.00	64.6
8	T1	All MCs	788	3.3	788	3.3	0.413	0.2	LOS A	0.0	0.0	0.00	0.00	0.00	79.7
Approach			795	3.3	795	3.3	0.413	0.2	NA	0.0	0.0	0.00	0.01	0.00	79.5
All Vehicles			1477	4.5	1477	4.5	0.436	2.2	NA	2.2	16.5	0.11	0.13	0.14	75.4

MOVEMENT SUMMARY

▽ Site: 101 [Tandys 2034 AM development (Site Folder: Option B)]

Output produced by SIDRA INTERSECTION Version: 9.1.1.200

New Site
Site Category: (None)
Give-Way (Two-Way)

Vehicle Movement Performance															
Mov ID	Turn	Mov Class	Demand Flows		Arrival Flows		Deg. Satn	Aver. Delay	Level of Service	95% Back Of Queue		Prop. Que	Eff. Stop Rate	Aver. No. of Cycles	Aver. Speed
			[Total veh/h]	[HV %]	[Total veh/h]	[HV %]				[Veh. veh]	[Dist m]				
South: Gulgan Road (S)															
2	T1	All MCs	646	6.2	646	6.2	0.467	1.3	LOS A	2.9	21.3	0.20	0.24	0.32	72.4
3	R2	All MCs	23	9.1	23	9.1	0.467	45.5	LOS D	2.9	21.3	0.20	0.24	0.32	63.8
3u	U	All MCs	19	0.0	19	0.0	0.467	63.7	LOS E	2.9	21.3	0.20	0.24	0.32	59.7
Approach			688	6.1	688	6.1	0.467	4.5	NA	2.9	21.3	0.20	0.24	0.32	71.7

East: Tandys Lane															
4	L2	All MCs	28	7.4	28	7.4	0.131	12.4	LOS A	0.4	3.0	0.79	0.92	0.79	51.5
6	R2	All MCs	8	0.0	8	0.0	0.131	42.4	LOS C	0.4	3.0	0.79	0.92	0.79	53.1
Approach			37	5.7	37	5.7	0.131	19.2	LOS B	0.4	3.0	0.79	0.92	0.79	51.9
North: Gulgan Road (N)															
7	L2	All MCs	6	0.0	6	0.0	0.003	6.9	LOS A	0.0	0.0	0.00	0.63	0.00	64.6
8	T1	All MCs	817	3.5	817	3.5	0.428	0.2	LOS A	0.0	0.0	0.00	0.00	0.00	79.6
Approach			823	3.5	823	3.5	0.428	0.2	NA	0.0	0.0	0.00	0.00	0.00	79.5
All Vehicles			1548	4.7	1548	4.7	0.467	2.6	NA	2.9	21.3	0.11	0.13	0.16	74.9

MOVEMENT SUMMARY

Site: 101 [Tandys 2024 PM background (Site Folder: Option B)]

Output produced by SIDRA INTERSECTION Version: 9.1.1.200

New Site
Site Category: (None)
Give-Way (Two-Way)

Vehicle Movement Performance															
Mov ID	Turn	Mov Class	Demand Flows		Arrival Flows		Deg. Satn	Aver. Delay	Level of Service	95% Back Of Queue		Prop. Que	Eff. Stop Rate	Aver. No. of Cycles	Aver. Speed
			[Total veh/h]	[HV %]	[Total veh/h]	[HV %]				[Veh. veh]	[Dist. m]				
South: Gulgan Road (S)															
2	T1	All MCs	544	1.4	544	1.4	0.330	0.0	LOS A	0.6	4.1	0.11	0.12	0.11	77.9
3	R2	All MCs	16	13.3	16	13.3	0.330	15.4	LOS B	0.6	4.1	0.11	0.12	0.11	66.5
3u	U	All MCs	19	0.0	19	0.0	0.330	17.5	LOS B	0.6	4.1	0.11	0.12	0.11	63.4
Approach			579	1.6	579	1.6	0.330	1.0	NA	0.6	4.1	0.11	0.12	0.11	77.0
East: Tandys Lane															
4	L2	All MCs	21	0.0	21	0.0	0.055	8.3	LOS A	0.2	1.3	0.58	0.72	0.58	59.4
6	R2	All MCs	9	11.1	9	11.1	0.055	19.9	LOS B	0.2	1.3	0.58	0.72	0.58	56.3
Approach			31	3.4	31	3.4	0.055	11.9	LOS A	0.2	1.3	0.58	0.72	0.58	58.4
North: Gulgan Road (N)															
7	L2	All MCs	7	0.0	7	0.0	0.004	6.9	LOS A	0.0	0.0	0.00	0.63	0.00	64.6
8	T1	All MCs	384	2.2	384	2.2	0.200	0.1	LOS A	0.0	0.0	0.00	0.00	0.00	79.9
Approach			392	2.2	392	2.2	0.200	0.2	NA	0.0	0.0	0.00	0.01	0.00	79.5
All Vehicles			1001	1.9	1001	1.9	0.330	1.0	NA	0.6	4.1	0.08	0.10	0.08	77.2

MOVEMENT SUMMARY

Site: 101 [Tandys 2034 PM background (Site Folder: Option B)]

Output produced by SIDRA INTERSECTION Version: 9.1.1.200

New Site
Site Category: (None)
Give-Way (Two-Way)

Vehicle Movement Performance															
Mov ID	Turn	Mov Class	Demand Flows		Arrival Flows		Deg. Satn	Aver. Delay	Level of Service	95% Back Of Queue		Prop. Que	Eff. Stop Rate	Aver. No. of Cycles	Aver. Speed
			[Total veh/h]	[HV %]	[Total veh/h]	[HV %]				[Veh. veh]	[Dist m]				
South: Gulgan Road (S)															
2	T1	All MCs	756	1.3	756	1.3	0.467	0.3	LOS A	1.5	10.6	0.13	0.16	0.18	76.7
3	R2	All MCs	19	0.0	19	0.0	0.467	19.9	LOS B	1.5	10.6	0.13	0.16	0.18	70.7
3u	U	All MCs	26	0.0	26	0.0	0.467	27.6	LOS B	1.5	10.6	0.13	0.16	0.18	62.6
Approach			801	1.2	801	1.2	0.467	1.7	NA	1.5	10.6	0.13	0.16	0.18	76.0
East: Tandys Lane															
4	L2	All MCs	29	0.0	29	0.0	0.168	9.3	LOS A	0.5	3.5	0.75	0.89	0.76	52.2
6	R2	All MCs	14	15.4	14	15.4	0.168	44.5	LOS D	0.5	3.5	0.75	0.89	0.76	48.9
Approach			43	4.9	43	4.9	0.168	20.4	LOS B	0.5	3.5	0.75	0.89	0.76	51.1
North: Gulgan Road (N)															
7	L2	All MCs	9	0.0	9	0.0	0.005	6.9	LOS A	0.0	0.0	0.00	0.63	0.00	64.6
8	T1	All MCs	535	2.4	535	2.4	0.278	0.1	LOS A	0.0	0.0	0.00	0.00	0.00	79.8
Approach			544	2.3	544	2.3	0.278	0.2	NA	0.0	0.0	0.00	0.01	0.00	79.5
All Vehicles			1388	1.7	1388	1.7	0.467	1.7	NA	1.5	10.6	0.10	0.12	0.13	76.2

MOVEMENT SUMMARY

▽ Site: 101 [Tandys 2034 PM development (Site Folder: Option B)]

Output produced by SIDRA INTERSECTION Version: 9.1.1.200

New Site
Site Category: (None)
Give-Way (Two-Way)

Vehicle Movement Performance															
Mov ID	Turn	Mov Class	Demand Flows		Arrival Flows		Deg. Satn	Aver. Delay	Level of Service	95% Back Of Queue		Prop. Que	Eff. Stop Rate	Aver. No. of Cycles	Aver. Speed
			[Total veh/h]	[HV %]	[Total veh/h]	[HV %]				[Veh. veh]	[Dist m]				
South: Gulgan Road (S)															
2	T1	All MCs	781	1.6	781	1.6	0.486	0.5	LOS A	1.8	12.8	0.13	0.16	0.20	76.3
3	R2	All MCs	19	0.0	19	0.0	0.486	21.9	LOS B	1.8	12.8	0.13	0.16	0.20	70.4
3u	U	All MCs	26	0.0	26	0.0	0.486	31.1	LOS C	1.8	12.8	0.13	0.16	0.20	62.3
Approach			826	1.5	826	1.5	0.486	1.9	NA	1.8	12.8	0.13	0.16	0.20	75.6
East: Tandys Lane															
4	L2	All MCs	29	0.0	29	0.0	0.196	9.9	LOS A	0.5	4.0	0.77	0.93	0.82	50.2
6	R2	All MCs	14	15.4	14	15.4	0.196	52.2	LOS D	0.5	4.0	0.77	0.93	0.82	47.1
Approach			43	4.9	43	4.9	0.196	23.3	LOS B	0.5	4.0	0.77	0.93	0.82	49.2
North: Gulgan Road (N)															
7	L2	All MCs	9	0.0	9	0.0	0.005	6.9	LOS A	0.0	0.0	0.00	0.63	0.00	64.6

8	T1	All MCs	573	2.9	573	2.9	0.299	0.1	LOS A	0.0	0.0	0.00	0.00	0.00	79.8
Approach			582	2.9	582	2.9	0.299	0.2	NA	0.0	0.0	0.00	0.01	0.00	79.5
All Vehicles			1452	2.2	1452	2.2	0.486	1.9	NA	1.8	12.8	0.10	0.12	0.14	75.9

MOVEMENT SUMMARY

Site: 101v [Mullumbimby Rd 2024 AM background (Site Folder: Option B)]

Output produced by SIDRA INTERSECTION Version: 9.1.1.200

New Site
Site Category: (None)
Give-Way (Two-Way)

Vehicle Movement Performance

Mov ID	Turn	Mov Class	Demand Flows		Arrival Flows		Deg. Satn	Aver. Delay	Level of Service	95% Back Of Queue		Prop. Que	Eff. Stop Rate	Aver. No. of Cycles	Aver. Speed
			[Total]	[HV]	[Total]	[HV]				[Veh.]	[Dist]				
			veh/h	%	veh/h	%	v/c	sec			veh	m			km/h
South: Gulgan Road															
1	L2	All MCs	323	5.5	323	5.5	0.190	8.0	LOS A	0.0	0.0	0.00	0.66	0.00	71.6
2	T1	All MCs	16	6.7	16	6.7	0.008	0.0	LOS A	0.0	0.0	0.00	0.00	0.00	100.0
Approach			339	5.6	339	5.6	0.190	7.6	NA	0.0	0.0	0.00	0.63	0.00	72.6
North: Gulgan Road															
8	T1	All MCs	26	4.0	26	4.0	0.014	0.0	LOS A	0.0	0.0	0.00	0.00	0.00	80.0
9	R2	All MCs	564	3.5	564	3.5	0.576	11.5	LOS B	5.2	37.2	0.62	0.84	0.92	59.1
Approach			591	3.6	591	3.6	0.576	10.9	NA	5.2	37.2	0.59	0.81	0.88	59.8
West: Mullumbimby															
10	L2	All MCs	434	6.1	434	6.1	0.335	7.1	LOS A	0.0	0.0	0.00	0.63	0.00	62.6
12	R2	All MCs	253	6.3	253	6.3	0.815	36.1	LOS E	6.5	48.2	0.93	1.32	2.43	41.8
Approach			686	6.1	686	6.1	0.815	17.8	LOS C	6.5	48.2	0.34	0.88	0.90	52.9
All Vehicles			1616	5.1	1616	5.1	0.815	13.2	NA	6.5	48.2	0.36	0.80	0.70	58.7

MOVEMENT SUMMARY

Site: 101v [Mullumbimby Rd 2034 AM background (Site Folder: Option B)]

Output produced by SIDRA INTERSECTION Version: 9.1.1.200

New Site
Site Category: (None)
Give-Way (Two-Way)

Vehicle Movement Performance

Mov ID	Turn	Mov Class	Demand Flows		Arrival Flows		Deg. Satn	Aver. Delay	Level of Service	95% Back Of Queue		Prop. Que	Eff. Stop Rate	Aver. No. of Cycles	Aver. Speed
			[Total]	[HV]	[Total]	[HV]				[Veh.]	[Dist]				
			veh/h	%	veh/h	%	v/c	sec			veh	m			km/h
South: Gulgan Road															
1	L2	All MCs	446	4.7	446	4.7	0.261	8.0	LOS A	0.0	0.0	0.00	0.66	0.00	71.9
2	T1	All MCs	26	8.0	26	8.0	0.014	0.0	LOS A	0.0	0.0	0.00	0.00	0.00	100.0

Approach		473	4.9	473	4.9	0.261	7.5	NA	0.0	0.0	0.00	0.62	0.00	73.1	
North: Gulgan Road															
8	T1	All MCs	38	5.6	38	5.6	0.034	1.1	LOS A	0.2	1.2	0.54	0.23	0.54	75.5
9	R2	All MCs	783	3.5	783	3.5	0.950	31.0	LOS D	25.3	182.2	0.96	1.84	3.95	45.0
Approach			821	3.6	821	3.6	0.950	29.6	NA	25.3	182.2	0.94	1.77	3.80	45.9
West: Mullumbimby															
10	L2	All MCs	604	6.1	604	6.1	0.467	7.1	LOS A	0.0	0.0	0.00	0.63	0.00	62.6
12	R2	All MCs	352	6.3	352	6.3	2.317	1224.7	LOS F	128.0	944.1	1.00	4.90	20.23	2.9
Approach			956	6.2	956	6.2	2.317	455.0	LOS F	128.0	944.1	0.37	2.20	7.44	7.2
All Vehicles			2249	5.0	2249	5.0	2.317	205.7	NA	128.0	944.1	0.50	1.71	4.55	14.4

MOVEMENT SUMMARY

Site: 101v [Mullumbimby Rd 2034 PM background (Site Folder: Option B)]

Output produced by SIDRA INTERSECTION Version: 9.1.1.200

New Site
Site Category: (None)
Give-Way (Two-Way)

Vehicle Movement Performance

Mov ID	Turn	Mov Class	Demand Flows		Arrival Flows		Deg. Satn	Aver. Delay	Level of Service	95% Back Of Queue		Prop. Que	Eff. Stop Rate	Aver. No. of Cycles	Aver. Speed
			[Total	HV]	[Total	HV]				[Veh.	Dist]				
			veh/h	%	veh/h	%	v/c	sec			veh	m			km/h
South: Gulgan Road															
1	L2	All MCs	446	4.7	446	4.7	0.261	8.0	LOS A	0.0	0.0	0.00	0.66	0.00	71.9
2	T1	All MCs	26	8.0	26	8.0	0.014	0.0	LOS A	0.0	0.0	0.00	0.00	0.00	100.0
Approach			473	4.9	473	4.9	0.261	7.5	NA	0.0	0.0	0.00	0.62	0.00	73.1
North: Gulgan Road															
8	T1	All MCs	38	5.6	38	5.6	0.034	2.4	LOS A	0.2	1.2	0.54	0.37	0.54	75.5
9	R2	All MCs	826	3.8	826	3.8	1.006	50.0	LOS F	38.4	277.4	1.00	2.34	5.57	36.5
Approach			864	3.9	864	3.9	1.006	47.9	NA	38.4	277.4	0.98	2.26	5.35	37.3
West: Mullumbimby															
10	L2	All MCs	648	6.5	648	6.5	0.502	7.1	LOS A	0.0	0.0	0.00	0.63	0.00	62.5
12	R2	All MCs	352	6.3	352	6.3	2.631	1510.4	LOS F	139.0	1025.3	1.00	4.85	20.26	2.3
Approach			1000	6.4	1000	6.4	2.631	535.7	LOS F	139.0	1025.3	0.35	2.11	7.12	6.2
All Vehicles			2337	5.2	2337	5.2	2.631	248.5	NA	139.0	1025.3	0.51	1.86	5.03	12.3

MOVEMENT SUMMARY

Site: 101v [Mullumbimby Rd 2024 PM background (Site Folder: Option B)]

Output produced by SIDRA INTERSECTION Version: 9.1.1.200

New Site
Site Category: (None)
Give-Way (Two-Way)

Vehicle Movement Performance															
Mov ID	Turn	Mov Class	Demand Flows		Arrival Flows		Deg. Satn	Aver. Delay	Level of Service	95% Back Of Queue		Prop. Que	Eff. Stop Rate	Aver. No. of Cycles	Aver. Speed
			[Total veh/h]	[HV %]	[Total veh/h]	[HV %]				[Veh. veh]	[Dist m]				
South: Gulgan Road															
1	L2	All MCs	301	2.4	301	2.4	0.173	7.9	LOS A	0.0	0.0	0.00	0.66	0.00	72.7
2	T1	All MCs	28	11.1	28	11.1	0.016	0.0	LOS A	0.0	0.0	0.00	0.00	0.00	100.0
Approach			329	3.2	329	3.2	0.173	7.2	NA	0.0	0.0	0.00	0.60	0.00	74.5
North: Gulgan Road															
8	T1	All MCs	27	3.8	27	3.8	0.015	0.0	LOS A	0.0	0.0	0.00	0.00	0.00	80.0
9	R2	All MCs	393	2.1	393	2.1	0.390	9.7	LOS A	2.3	16.1	0.52	0.73	0.59	61.2
Approach			420	2.3	420	2.3	0.390	9.1	NA	2.3	16.1	0.48	0.68	0.55	62.2
West: Mullumbimby															
10	L2	All MCs	545	1.4	545	1.4	0.718	9.0	LOS A	8.5	60.4	0.20	0.74	0.43	60.6
12	R2	All MCs	282	1.5	282	1.5	0.718	23.7	LOS C	8.5	60.4	0.83	1.06	1.76	51.8
Approach			827	1.4	827	1.4	0.718	14.0	LOS B	8.5	60.4	0.42	0.85	0.88	57.2
All Vehicles			1577	2.0	1577	2.0	0.718	11.3	NA	8.5	60.4	0.35	0.75	0.61	61.5

MOVEMENT SUMMARY

▽ Site: 101v [Mullumbimby Rd 2034 PM background (Site Folder: Option B)]

Output produced by SIDRA INTERSECTION Version: 9.1.1.200

New Site
Site Category: (None)
Give-Way (Two-Way)

Vehicle Movement Performance															
Mov ID	Turn	Mov Class	Demand Flows		Arrival Flows		Deg. Satn	Aver. Delay	Level of Service	95% Back Of Queue		Prop. Que	Eff. Stop Rate	Aver. No. of Cycles	Aver. Speed
			[Total veh/h]	[HV %]	[Total veh/h]	[HV %]				[Veh. veh]	[Dist m]				
South: Gulgan Road															
1	L2	All MCs	418	2.3	418	2.3	0.240	7.9	LOS A	0.0	0.0	0.00	0.66	0.00	72.8
2	T1	All MCs	41	12.8	41	12.8	0.023	0.0	LOS A	0.0	0.0	0.00	0.00	0.00	100.0
Approach			459	3.2	459	3.2	0.240	7.2	NA	0.0	0.0	0.00	0.60	0.00	74.6
North: Gulgan Road															
8	T1	All MCs	39	5.4	39	5.4	0.021	0.0	LOS A	0.0	0.0	0.00	0.00	0.00	80.0
9	R2	All MCs	546	2.1	546	2.1	0.637	13.4	LOS B	5.8	41.5	0.71	0.98	1.23	57.7
Approach			585	2.3	585	2.3	0.637	12.5	NA	5.8	41.5	0.66	0.92	1.15	58.7
West: Mullumbimby															
10	L2	All MCs	758	1.3	758	1.3	1.281	15.5	LOS C	65.2	462.5	0.03	0.73	0.40	55.6
12	R2	All MCs	393	1.6	393	1.6	1.281	287.7	LOS F	65.2	462.5	1.00	3.69	12.84	10.9
Approach			1151	1.4	1151	1.4	1.281	108.4	LOS F	65.2	462.5	0.36	1.74	4.65	23.1

All Vehicles	2195	2.0	2195	2.0	1.281	61.7	NA	65.2	462.5	0.37	1.28	2.74	33.3
--------------	------	-----	------	-----	-------	------	----	------	-------	------	------	------	------

MOVEMENT SUMMARY

Site: 101v [Mullumbimby Rd 2034 PM development (Site Folder: Option B)]

Output produced by SIDRA INTERSECTION Version: 9.1.1.200

New Site
Site Category: (None)
Give-Way (Two-Way)

Vehicle Movement Performance															
Mov ID	Turn	Mov Class	Demand Flows		Arrival Flows		Deg. Satn	Aver. Delay	Level of Service	95% Back Of Queue		Prop. Que	Eff. Stop Rate	Aver. No. of Cycles	Aver. Speed
			[Total veh/h]	[HV %]	[Total veh/h]	[HV %]				[Veh. veh]	[Dist m]				
South: Gulgan Road															
1	L2	All MCs	418	2.3	418	2.3	0.240	7.9	LOS A	0.0	0.0	0.00	0.66	0.00	72.8
2	T1	All MCs	41	12.8	41	12.8	0.023	0.0	LOS A	0.0	0.0	0.00	0.00	0.00	100.0
Approach			459	3.2	459	3.2	0.240	7.2	NA	0.0	0.0	0.00	0.60	0.00	74.6
North: Gulgan Road															
8	T1	All MCs	39	5.4	39	5.4	0.021	0.0	LOS A	0.0	0.0	0.00	0.00	0.00	80.0
9	R2	All MCs	584	2.7	584	2.7	0.685	14.2	LOS B	7.0	49.9	0.74	1.03	1.38	56.8
Approach			623	2.9	623	2.9	0.685	13.4	NA	7.0	49.9	0.69	0.97	1.29	57.8
West: Mullumbimby															
10	L2	All MCs	783	1.6	783	1.6	0.592	7.1	LOS A	0.0	0.0	0.00	0.63	0.00	64.0
12	R2	All MCs	393	1.6	393	1.6	1.373	369.1	LOS F	73.1	518.8	1.00	3.94	14.56	8.7
Approach			1176	1.6	1176	1.6	1.373	128.0	LOS F	73.1	518.8	0.33	1.74	4.86	20.5
All Vehicles			2258	2.3	2258	2.3	1.373	71.8	NA	73.1	518.8	0.36	1.29	2.89	30.5

APPENDIX I – SIDRA OUTPUT OPTION C

MOVEMENT SUMMARY

 **Site: 101vvv [Option C Access Road 2034 AM (Site Folder: Option C)]**

Output produced by SIDRA INTERSECTION Version: 9.1.1.200

New Site

Site Category: (None)

Signals - EQUISAT (Fixed-Time/SCATS) Isolated Cycle Time = 50 seconds (Site Practical Cycle Time)

Vehicle Movement Performance

Mov ID	Turn	Mov Class	Demand Flows		Arrival Flows		Deg. Satn	Aver. Delay	Level of Service	95% Back Of Queue		Prop. Que	Eff. Stop Rate	Aver. No. of Cycles	Aver. Speed
			[Total veh/h]	[HV %]	[Total veh/h]	[HV %]				[Veh. veh]	[Dist m]				
South: Gulgan Road South															
1	L2	All MCs	43	9.8	43	9.8	0.040	10.0	LOS B	0.4	3.3	0.43	0.65	0.43	49.4
2	T1	All MCs	622	6.3	622	6.3	* 0.890	27.0	LOS C	19.1	141.1	1.00	1.13	1.40	41.6
Approach			665	6.5	665	6.5	0.890	25.9	LOS C	19.1	141.1	0.96	1.10	1.34	42.0
North: Gulgan Road North															
8	T1	All MCs	778	2.4	778	2.4	0.611	5.8	LOS A	11.3	80.9	0.64	0.57	0.64	54.8
9	R2	All MCs	231	10.5	231	10.5	* 0.805	32.7	LOS C	6.4	48.9	1.00	0.98	1.35	37.9
Approach			1008	4.3	1008	4.3	0.805	11.9	LOS B	11.3	80.9	0.72	0.67	0.80	49.7
West: Proposed Access															
10	L2	All MCs	153	10.3	153	10.3	0.172	11.7	LOS B	1.8	14.0	0.60	0.69	0.60	48.5
12	R2	All MCs	29	10.7	29	10.7	* 0.137	30.6	LOS C	0.7	5.3	0.93	0.71	0.93	39.6
Approach			182	10.4	182	10.4	0.172	14.8	LOS B	1.8	14.0	0.65	0.69	0.65	46.8
All Vehicles			1856	5.7	1856	5.7	0.890	17.2	LOS B	19.1	141.1	0.80	0.82	0.98	46.4

MOVEMENT SUMMARY

 **Site: 101vvv [Option C Access Road 2044 AM (Site Folder: Option C)]**

Output produced by SIDRA INTERSECTION Version: 9.1.1.200

New Site

Site Category: (None)

Signals - EQUISAT (Fixed-Time/SCATS) Isolated Cycle Time = 70 seconds (Site Practical Cycle Time)

Vehicle Movement Performance

Mov ID	Turn	Mov Class	Demand Flows		Arrival Flows		Deg. Satn	Aver. Delay	Level of Service	95% Back Of Queue		Prop. Que	Eff. Stop Rate	Aver. No. of Cycles	Aver. Speed
			[Total veh/h]	[HV %]	[Total veh/h]	[HV %]				[Veh. veh]	[Dist m]				
South: Gulgan Road South															

1	L2	All MCs	43	9.8	43	9.8	0.035	16.2	LOS B	0.5	3.5	0.34	0.64	0.34	49.8
2	T1	All MCs	864	6.2	864	6.2 *	0.887	33.7	LOS C	33.2	244.7	0.96	1.05	1.18	41.7
Approach			907	6.4	907	6.4	0.887	32.8	LOS C	33.2	244.7	0.93	1.03	1.14	42.0
North: Gulgan Road North															
8	T1	All MCs	1083	2.5	1083	2.5	0.782	7.9	LOS A	22.9	164.0	0.67	0.62	0.67	54.4
9	R2	All MCs	231	10.5	231	10.5 *	0.901	51.3	LOS D	9.7	74.1	1.00	1.08	1.53	32.2
Approach			1314	3.9	1314	3.9	0.901	15.5	LOS B	22.9	164.0	0.72	0.70	0.82	48.5
West: Proposed Access															
10	L2	All MCs	153	10.3	153	10.3	0.213	17.1	LOS B	3.1	24.0	0.67	0.72	0.67	45.3
12	R2	All MCs	29	10.7	29	10.7 *	0.192	44.4	LOS D	1.0	7.7	0.96	0.71	0.96	35.2
Approach			182	10.4	182	10.4	0.213	21.5	LOS C	3.1	24.0	0.72	0.72	0.72	43.3
All Vehicles			2403	5.3	2403	5.3	0.901	22.5	LOS C	33.2	244.7	0.80	0.82	0.93	45.4

MOVEMENT SUMMARY

 Site: 101vvv [Option C Access Road 2034 PM (Site Folder: Option C)]

Output produced by SIDRA INTERSECTION Version: 9.1.1.200

New Site

Site Category: (None)

Signals - EQUISAT (Fixed-Time/SCATS) Isolated Cycle Time = 60 seconds (Site Practical Cycle Time)

Vehicle Movement Performance

Mov ID	Turn	Mov Class	Demand Flows		Arrival Flows		Deg. Satn	Aver. Delay	Level of Service	95% Back Of Queue		Prop. Que	Eff. Stop Rate	Aver. No. of Cycles	Aver. Speed
			[Total	HV]	[Total	HV]				[Veh.	Dist]				
			veh/h	%	veh/h	%	v/c	sec		veh	m				km/h
South: Gulgan Road South															
1	L2	All MCs	25	12.5	25	12.5	0.020	11.2	LOS B	0.2	1.7	0.32	0.63	0.32	50.3
2	T1	All MCs	780	2.3	780	2.3 *	0.790	18.8	LOS B	20.8	148.8	0.89	0.86	0.97	47.5
Approach			805	2.6	805	2.6	0.790	18.5	LOS B	20.8	148.8	0.87	0.85	0.95	47.5
North: Gulgan Road North															
8	T1	All MCs	552	2.5	552	2.5	0.396	4.0	LOS A	6.7	47.8	0.45	0.40	0.45	56.3
9	R2	All MCs	133	10.3	133	10.3 *	0.740	38.3	LOS D	4.3	32.7	1.00	0.90	1.26	35.8
Approach			684	4.0	684	4.0	0.740	10.7	LOS B	6.7	47.8	0.55	0.49	0.60	50.7
West: Proposed Access															
10	L2	All MCs	191	6.6	191	6.6	0.248	13.3	LOS B	3.0	22.3	0.64	0.73	0.64	47.6
12	R2	All MCs	46	27.3	46	27.3 *	0.287	36.7	LOS D	1.4	11.8	0.96	0.74	0.96	36.7
Approach			237	10.7	237	10.7	0.287	17.9	LOS B	3.0	22.3	0.70	0.73	0.70	45.0
All Vehicles			1726	4.3	1726	4.3	0.790	15.3	LOS B	20.8	148.8	0.72	0.69	0.78	48.3

MOVEMENT SUMMARY

 Site: 101vvv [Option C Access Road 2044 PM (Site Folder: Option C)]

Output produced by SIDRA INTERSECTION Version: 9.1.1.200

New Site

Site Category: (None)

Signals - EQUISAT (Fixed-Time/SCATS) Isolated Cycle Time = 80 seconds (Site Practical Cycle Time)

Vehicle Movement Performance															
Mov ID	Turn	Mov Class	Demand Flows		Arrival Flows		Deg. Satn	Aver. Delay	Level of Service	95% Back Of Queue		Prop. Que Stop	Eff. Rate	Aver. No. of Cycles	Aver. Speed
			[Total veh/h]	[HV %]	[Total veh/h]	[HV %]				[Veh. veh]	[Dist m]				
South: Gulgan Road South															
1	L2	All MCs	25	12.5	25	12.5	0.019	16.0	LOS B	0.2	1.8	0.25	0.62	0.25	50.6
2	T1	All MCs	1084	2.2	1084	2.2	* 0.903	33.8	LOS C	45.8	326.4	0.94	1.00	1.11	42.1
Approach			1109	2.5	1109	2.5	0.903	33.4	LOS C	45.8	326.4	0.93	0.99	1.09	42.3
North: Gulgan Road North															
8	T1	All MCs	834	2.7	834	2.7	0.541	3.7	LOS A	12.5	89.2	0.42	0.39	0.42	56.6
9	R2	All MCs	133	10.3	133	10.3	* 0.845	52.5	LOS D	5.9	45.2	1.00	0.98	1.41	31.5
Approach			966	3.7	966	3.7	0.845	10.4	LOS B	12.5	89.2	0.50	0.47	0.56	51.0
West: Proposed Access															
10	L2	All MCs	191	6.6	191	6.6	0.331	23.7	LOS C	5.6	41.3	0.80	0.78	0.80	42.0
12	R2	All MCs	46	27.3	46	27.3	* 0.383	50.3	LOS D	1.9	16.2	0.99	0.74	0.99	32.7
Approach			237	10.7	237	10.7	0.383	28.9	LOS C	5.6	41.3	0.84	0.77	0.84	39.8
All Vehicles			2313	3.8	2313	3.8	0.903	23.3	LOS C	45.8	326.4	0.74	0.75	0.84	45.2

APPENDIX J – SIDRA OUTPUT OPTION D

MOVEMENT SUMMARY

▽ Site: 101vv [Access Road CHR(S) 2034 AM - BILS traffic (Site Folder: Option D)]

Output produced by SIDRA INTERSECTION Version: 9.1.1.200

New Site

Site Category: (None)

Give-Way (Two-Way)

Vehicle Movement Performance															
Mov ID	Turn	Mov Class	Demand Flows		Arrival Flows		Deg. Satn	Aver. Delay	Level of Service	95% Back Of Queue		Prop. Que	Eff. Stop Rate	Aver. No. of Cycles	Aver. Speed
			[Total veh/h]	[HV %]	[Total veh/h]	[HV %]				[Veh. veh]	[Dist m]				
South: Gulgan Road South															
1	L2	All MCs	43	9.8	43	9.8	0.024	5.7	LOS A	0.0	0.0	0.00	0.57	0.00	52.5
2	T1	All MCs	622	6.3	622	6.3	0.320	0.1	LOS A	0.0	0.0	0.00	0.00	0.00	59.8
Approach			665	6.5	665	6.5	0.320	0.5	NA	0.0	0.0	0.00	0.04	0.00	59.3
North: Gulgan Road North															
8	T1	All MCs	778	2.4	778	2.4	0.391	0.1	LOS A	0.0	0.0	0.00	0.00	0.00	59.7
9	R2	All MCs	229	10.1	229	10.1	0.406	12.9	LOS B	2.0	15.2	0.69	0.95	0.95	47.6
Approach			1007	4.2	1007	4.2	0.406	3.1	NA	2.0	15.2	0.16	0.22	0.22	56.5
West: Proposed Access															
10	L2	All MCs	153	10.3	153	10.3	0.276	11.4	LOS B	1.1	8.1	0.63	0.86	0.72	48.8
12	R2	All MCs	29	10.7	29	10.7	0.889	189.7	LOS F	2.4	18.6	0.99	1.16	1.72	14.6
Approach			182	10.4	182	10.4	0.889	40.3	LOS E	2.4	18.6	0.69	0.91	0.88	35.4
All Vehicles			1855	5.6	1855	5.6	0.889	5.8	NA	2.4	18.6	0.15	0.22	0.20	54.2

MOVEMENT SUMMARY

▽ Site: 101vv [Access Road CHR(S) 2034 PM - BILS traffic (Site Folder: Option D)]

Output produced by SIDRA INTERSECTION Version: 9.1.1.200

New Site

Site Category: (None)

Give-Way (Two-Way)

Vehicle Movement Performance															
Mov ID	Turn	Mov Class	Demand Flows		Arrival Flows		Deg. Satn	Aver. Delay	Level of Service	95% Back Of Queue		Prop. Que	Eff. Stop Rate	Aver. No. of Cycles	Aver. Speed
			[Total veh/h]	[HV %]	[Total veh/h]	[HV %]				[Veh. veh]	[Dist m]				
South: Gulgan Road South															
1	L2	All MCs	25	12.5	25	12.5	0.014	5.7	LOS A	0.0	0.0	0.00	0.57	0.00	52.4
2	T1	All MCs	780	2.3	780	2.3	0.392	0.1	LOS A	0.0	0.0	0.00	0.00	0.00	59.7
Approach			805	2.6	805	2.6	0.392	0.3	NA	0.0	0.0	0.00	0.02	0.00	59.5
North: Gulgan Road North															
8	T1	All MCs	554	2.9	554	2.9	0.279	0.1	LOS A	0.0	0.0	0.00	0.00	0.00	59.8
9	R2	All MCs	133	10.3	133	10.3	0.304	14.5	LOS B	1.2	9.1	0.74	0.93	0.89	46.7
Approach			686	4.3	686	4.3	0.304	2.9	NA	1.2	9.1	0.14	0.18	0.17	56.8

West: Proposed Access															
10	L2	All MCs	191	6.6	191	6.6	0.435	15.2	LOS C	1.9	13.8	0.77	0.98	1.07	46.6
12	R2	All MCs	46	27.3	46	27.3	1.356	484.6	LOS F	9.9	85.7	1.00	1.92	4.72	6.7
Approach			237	10.7	237	10.7	1.356	107.0	LOS F	9.9	85.7	0.81	1.16	1.78	21.6
All Vehicles			1728	4.4	1728	4.4	1.356	15.9	NA	9.9	85.7	0.17	0.24	0.31	47.2

MOVEMENT SUMMARY

▽ Site: 101vv [Access Road CHR(S) 2044 AM - BILS traffic (Site Folder: Option D)]

Output produced by SIDRA INTERSECTION Version: 9.1.1.200

New Site

Site Category: (None)

Give-Way (Two-Way)

Vehicle Movement Performance															
Mov ID	Turn	Mov Class	Demand Flows		Arrival Flows		Deg. Satn	Aver. Delay	Level of Service	95% Back Of Queue		Prop. Que	Eff. Stop Rate	Aver. No. of Cycles	Aver. Speed
			[Total veh/h]	[HV %]	[Total veh/h]	[HV %]				[Veh. veh]	[Dist m]				
South: Gulgan Road South															
1	L2	All MCs	43	9.8	43	9.8	0.024	5.7	LOS A	0.0	0.0	0.00	0.57	0.00	52.5
2	T1	All MCs	864	6.2	864	6.2	0.445	0.2	LOS A	0.0	0.0	0.00	0.00	0.00	59.7
Approach			907	6.4	907	6.4	0.445	0.4	NA	0.0	0.0	0.00	0.03	0.00	59.3
North: Gulgan Road North															
8	T1	All MCs	1083	2.5	1083	2.5	0.545	0.2	LOS A	0.0	0.0	0.00	0.00	0.00	59.5
9	R2	All MCs	231	10.5	231	10.5	0.679	24.5	LOS C	3.6	27.8	0.90	1.19	1.72	41.4
Approach			1314	3.9	1314	3.9	0.679	4.5	NA	3.6	27.8	0.16	0.21	0.30	55.3
West: Proposed Access															
10	L2	All MCs	153	10.3	153	10.3	0.465	19.3	LOS C	1.8	13.9	0.83	1.02	1.18	44.2
12	R2	All MCs	29	10.7	29	10.7	3.395	2512.7	LOS F	15.8	120.9	1.00	1.34	2.61	1.4
Approach			182	10.4	182	10.4	3.395	422.8	LOS F	15.8	120.9	0.86	1.07	1.41	7.6
All Vehicles			2403	5.3	2403	5.3	3.395	34.7	NA	15.8	120.9	0.15	0.21	0.27	38.0

MOVEMENT SUMMARY

▽ Site: 101vv [Access Road CHR(S) 2044 PM - BILS traffic (Site Folder: Option D)]

Output produced by SIDRA INTERSECTION Version: 9.1.1.200

New Site

Site Category: (None)

Give-Way (Two-Way)

Vehicle Movement Performance															
Mov ID	Turn	Mov Class	Demand Flows		Arrival Flows		Deg. Satn	Aver. Delay	Level of Service	95% Back Of Queue		Prop. Que	Eff. Stop Rate	Aver. No. of Cycles	Aver. Speed
			[Total veh/h]	[HV %]	[Total veh/h]	[HV %]				[Veh. veh]	[Dist m]				
South: Gulgan Road South															

1	L2	All MCs	43	9.8	43	9.8	0.024	5.7	LOS A	0.0	0.0	0.00	0.57	0.00	52.5
2	T1	All MCs	864	6.2	864	6.2	0.445	0.2	LOS A	0.0	0.0	0.00	0.00	0.00	59.7
Approach			907	6.4	907	6.4	0.445	0.4	NA	0.0	0.0	0.00	0.03	0.00	59.3
North: Gulgan Road North															
8	T1	All MCs	1083	2.5	1083	2.5	0.545	0.2	LOS A	0.0	0.0	0.00	0.00	0.00	59.5
9	R2	All MCs	231	10.5	231	10.5	0.679	24.5	LOS C	3.6	27.8	0.90	1.19	1.72	41.4
Approach			1314	3.9	1314	3.9	0.679	4.5	NA	3.6	27.8	0.16	0.21	0.30	55.3
West: Proposed Access															
10	L2	All MCs	153	10.3	153	10.3	0.465	19.3	LOS C	1.8	13.9	0.83	1.02	1.18	44.2
12	R2	All MCs	29	10.7	29	10.7	3.395	2512.7	LOS F	15.8	120.9	1.00	1.34	2.61	1.4
Approach			182	10.4	182	10.4	3.395	422.8	LOS F	15.8	120.9	0.86	1.07	1.41	7.6
All Vehicles			2403	5.3	2403	5.3	3.395	34.7	NA	15.8	120.9	0.15	0.21	0.27	38.0

Regards,



Michiel Kamphorst

MSc | BSc | RPEng | RPEQ | NER
Director & Principal Engineer

a: Suite 3, 70 Main Street, Alstonville
m: 0417 264 987
e: michiel@ingenconsulting.com.au



From: Matt Adams <Matt.ADAMS@transport.nsw.gov.au>
Sent: Friday, 10 September 2021 3:24 PM
To: Michiel Kamphorst <michiel@ingenconsulting.com.au>; Development Northern <development.northern@transport.nsw.gov.au>
Cc: abel@thecreativecapital.company; Steve Connelly <steve@plannersnorth.com.au>; rob doolan <balancedadvice@gmail.com>
Subject: RE: Planning Proposal for Byron Shire Business and Industrial Lands Strategy Area 5 - Gulgan North (Brunswick Heads)

Hi Michiel,

Further to your below enquiry, I have obtained feedback from our Regional Planning team. I can confirm that there are currently no plans for upgrades to the Pacific Highway interchange in this location.

Where development of the subject land for commercial purposes is proposed, any Planning Proposal will need to address the Section 9.1 Direction 5.4 with respect to location of such uses in out-of-town locations and adjacent to the Pacific Highway.

It is noted that the Pacific Highway & Gulgan Road interchange does support AM / PM peak traffic movements between the Byron and Brunswick catchments and that the interchange is subject to variations in demand during seasonal and event peak periods.

Any Traffic Impact Assessment (TIA) prepared in support of a Planning Proposal for this location must include sensitivity analysis of opening and future traffic impacts under Hundredth Highest Hour (HHV) volumes.

Please let me know if you have any further questions or would like feedback on the baseline methodology during preparation of any TIA.

For background, find attached copies of Roads and Maritime comment on the subject area and supporting strategies.

Best Regards

Matt Adams
Team Leader, Development Services
Community and Place | Region North
Regional & Outer Metropolitan
Transport for NSW

P 02 6640 1362
M 0400 474 068

3. The Planning Proposal for the additional area did not include a Traffic Impact Assessment (TIA) for the additional proposed employment lands, or assess the safety and transport impacts on Saddle and Gulgan Roads. The proposed development will have to create new intersections with one or both of these roads. It should be noted that access onto Gulgan Road would be the preferred option rather than access onto The Saddle Road.
4. If development of the proposed employment lands proceeds, a TIA (or addendum to the existing TIA) should be prepared by a suitably qualified person to identify likely traffic impacts on the classified roads. Roads and Maritime would be willing to review the TIA for Council at the relevant stage of development.

The TIA should be prepared in accordance with the current *Austrroads Guide to Traffic Management Part 12*, the complementary Roads and Maritime Supplement and the *RTA Guide to Traffic Generating Developments*. The TIA should include, but not be limited to, the following;

- The impact of the proposed development on the road network with consideration for a 10 year design horizon.
- The volume and distribution of traffic generated by the proposed development. Should future employment lands be developed in stages, the cumulative impact of the stages should be considered in totality.
- Background traffic data, including current traffic counts and relevant growth rates.
- Sight distance measurements at site access locations and affected intersections.
- Proposed site access arrangements and details of proposed improvements to any affected intersections. This should include consideration of turning lane warrants and identification of appropriate intersection treatments based on *Austrroads Guide to Traffic Management Part 6* and *Austrroads Guide to Road design Part 4A*.
- Details of servicing and parking arrangements, including swept paths for the largest vehicle requiring access to the site.
- Impact on public transport (public and school bus routes).
- Connectivity for active transport modes such as walking and cycling.

Any new access or works proposed on the classified road should be designed in accordance with the current *Austrroads Guidelines*, *Australian Standards* and *Roads and Maritime Supplements*, to the satisfaction of Council, prior to referral to Roads and Maritime for concurrence under Section 138 of the *Roads Act*.

If you have any further enquiries regarding the above comments please do not hesitate to contact Cheryl Sisson, Development Assessment Officer on (02) 6640 1362 or via email at: development.northern@rms.nsw.gov.au

Yours faithfully,



For John Perkins,
A/Manager Land Use Assessment, Northern
7 August 2019

E development.northern@transport.nsw.gov.au
A Level 1, 76 Victoria Street, Grafton NSW 2460



Transport
for NSW

I acknowledge the traditional owners and custodians of the land in which I work and pay my respects to Elders past, present and future.

From: Michiel Kamphorst [<mailto:michiel@ingenconsulting.com.au>]
Sent: Thursday, 19 August 2021 9:16 AM
To: Development Northern <development.northern@transport.nsw.gov.au>
Cc: abel@thecreativecapital.com.au; Steve Connelly <steve@plannersnorth.com.au>; rob doolan <balancedadvice@gmail.com>
Subject: RE: Planning Proposal for Byron Shire Business and Industrial Lands Strategy Area 5 - Gulgan North (Brunswick Heads)

CAUTION: This email is sent from an external source. Do not click any links or open attachments unless you recognise the sender and know the content is safe.

Hi Matt,

Thanks for getting back, good to hear from you.

I look forward to finding out if there are any PM projects relevant to the subject site and will use the proper Development Northern e-mail address as suggested.

Thanks again.

Regards,



Michiel Kamphorst

MSc | BSc | RPEng | RPEQ | NER
Director & Principal Engineer

m: 0417 264 987
e: michiel@ingenconsulting.com.au



From: Development Northern <development.northern@transport.nsw.gov.au>
Sent: Monday, August 16, 2021 4:00 PM
To: Michiel Kamphorst <michiel@ingenconsulting.com.au>
Cc: abel@thecreativecapital.com.au; Steve Connelly <steve@plannersnorth.com.au>; rob doolan <balancedadvice@gmail.com>
Subject: FW: Planning Proposal for Byron Shire Business and Industrial Lands Strategy Area 5 - Gulgan North (Brunswick Heads)

Hi Michiel,

Thanks for contacting Transport for NSW.

I note that your enquiry was initially directed via our new Community and Partnering team and has now been passed to Development Services for a response.

I note that the Proponent is preparing a Traffic Impact Assessment (TIA) to inform the scope of proposed land use and supporting road / transport infrastructure.

TfNSW is available to provide comment on any draft TIA and can provide feedback on the merits of proposed treatments. Where the road side environment and proposed access treatment result in a change in the road environment, then a speed zone review will be undertaken in accordance with the NSW Speed Zoning Guidelines. Where the option for a roundabout treatment is supported, then it will typically necessitate a change in speed zoning, which would occur following installation of such treatment.

I am currently checking with our Regional Planning team to obtain feedback on any future considerations for the Pacific Motorway. My team will prioritise a review of your enquiry and get back to you as soon as we complete our enquiries.

For future reference, all matters relating to Land Use Planning, Planning Proposals, Development Applications and related developer works can be directed to: development.northern@transport.nsw.gov.au

Please contact me if you have any questions.

Best Regards

Matt Adams
Team Leader, Development Services
Community and Place | Region North
Regional & Outer Metropolitan
Transport for NSW

P 02 6640 1362
M 0400 474 068
E development.northern@transport.nsw.gov.au
A Level 1, 76 Victoria Street, Grafton NSW 2460



I acknowledge the traditional owners and custodians of the land in which I work and pay my respects to Elders past, present and future.

From: Michiel Kamphorst <michiel@ingenconsulting.com.au>
Sent: Friday, August 13, 2021 4:55:03 PM
To: Penny Sutton <Penny.SUTTON@transport.nsw.gov.au>
Cc: Abel East <abel@thecreativecapital.com.au>; Steve Connelly <steve@plannersnorth.com.au>; rob doolan <balancedadvice@gmail.com>
Subject: RE: Planning Proposal for Byron Shire Business and Industrial Lands Strategy Area 5 - Gulgan North (Brunswick Heads)

CAUTION: This email is sent from an external source. Do not click any links or open attachments unless you recognise the sender and know the content is safe.

Hi Penny,

I'm just following up on the e-mail below to make sure you received it? We would much appreciate your feedback regarding this query.

Thank you.

Regards,



Michiel Kamphorst

MSc | BSc | RPEng | RPEQ | NER
Director & Principal Engineer

m: 0417 264 987

e: michiel@ingenconsulting.com.au



From: Michiel Kamphorst

Sent: Tuesday, 27 July 2021 10:46 AM

To: penny.sutton@transport.nsw.gov.au

Cc: Abel East <abel@thecreativecapital.com.au>; Steve Connelly <steve@plannersnorth.com.au>; rob doolan <balancedadvice@gmail.com>

Subject: Planning Proposal for Byron Shire Business and Industrial Lands Strategy Area 5 - Gulgan North (Brunswick Heads)

Dear Penny Sutton,

I am assisting the owners of 66 The Saddle Road in Brunswick Heads and their consultant team to prepare a Planning Proposal for this site, to achieve Council's desire for this land (Area 5) as outlined in the Byron Shire Business and Industrial Lands Strategy (see snapshot below). Council's traffic engineer Andrew Pearce was kind enough to provide me with your contact details in this context.

We are looking at proposing a new intersection to be constructed on Gulgan Road in the location shown below to provide access to the development areas. A roundabout would be our preferred option, considering local site constraints (Rous Water trunk main, vegetation, NBN line, overhead powerlines), truck manoeuvring, approach distances and intersection safety and capacity. The existing 60 speed sign (shown on the attached photo, western approach of the intersection) would need to be relocated further west to include this new roundabout in the 60km/h posted speed limit zone.

We would like to start the conversation with TfNSW about this proposal. It affects speed zoning on Gulgan Road, is located near the Gulgan Road roundabout and motorway off- and on-ramps and may affect any plans or strategies TfNSW may have for the Pacific Motorway in this area.

Does TfNSW have any feedback or comments that you are willing to provide at this early stage? TfNSW will no doubt be included in the Planning Proposal assessment process for which we will prepare a detailed Traffic Impact Study, but we'd like to iron out any potential issues before submitting the PP. I would be happy to meet in person or via Teams/Zoom to discuss if that assists. Please feel free to contact me with any questions.

Thank you.

Area 5: Gulgan North

Area Number	5.
Description	Part of Lot 2 DP 1159910 66 The Saddle Road, Brunswick Heads

Image of investigation area



Potential developable land¹ (ha)	6.5 ha
Preferred role	'A' proposes business park type development – buildings housing multiple small businesses 'B' a traditional industrial estate, allowing larger footprints for warehouse style uses requiring truck manoeuvring.
Strengths/ advantages	<ul style="list-style-type: none"> • under single ownership • proximity to direct north and south-bound ingress and egress to Pacific Highway • on existing public transport route • flood free and Area B relatively flat • proximity to workforce including expanding residential area of Bayshore Brunswick Heads with potential for 250 plus homes • links with the proposed new on-road cycle lane on Mullumbimby Road and Gulgan Road between Manns Road and Gulgan North Pacific Highway interchange



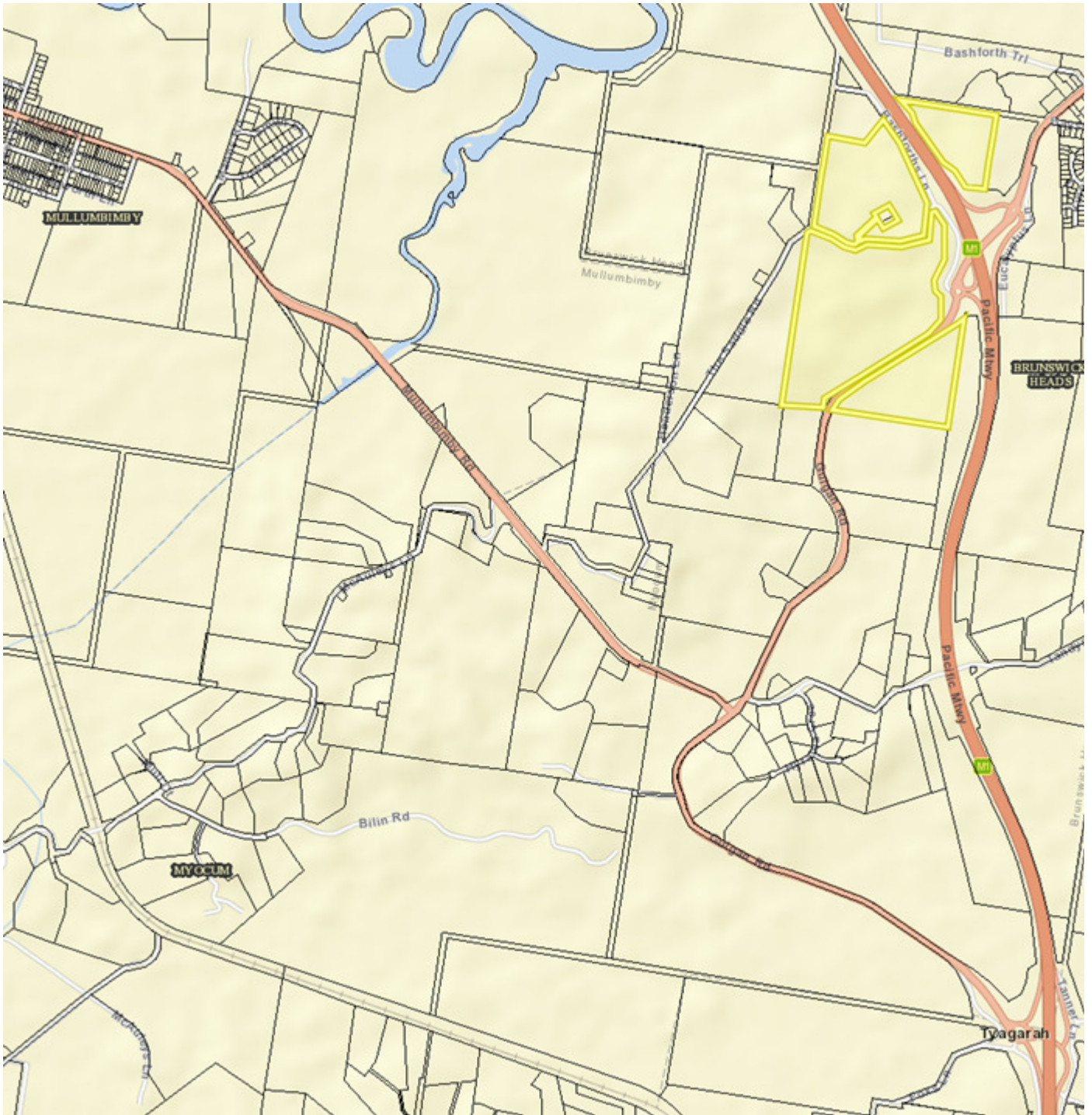

Regards,

INGEN
CONSULTING
ENGINEERED WITH PURPOSE

Michiel Kamphorst

MSc | BSc | RPEng | RPEQ | NER
Director & Principal Engineer

m: 0417 264 987

e: michiel@ingenconsulting.com.au



This email is intended only for the addressee and may contain confidential information. If you receive this email in error please delete it and any attachments and notify the sender immediately by reply email. Transport for NSW takes all care to ensure that attachments are free from viruses or

other defects. Transport for NSW assume no liability for any loss, damage or other consequences which may arise from opening or using an attachment.

 **Consider the environment. Please don't print this e-mail unless really necessary.**

This email is intended only for the addressee and may contain confidential information. If you receive this email in error please delete it and any attachments and notify the sender immediately by reply email. Transport for NSW takes all care to ensure that attachments are free from viruses or other defects. Transport for NSW assume no liability for any loss, damage or other consequences which may arise from opening or using an attachment.

 **Consider the environment. Please don't print this e-mail unless really necessary.**

This email is intended only for the addressee and may contain confidential information. If you receive this email in error please delete it and any attachments and notify the sender immediately by reply email. Transport for NSW takes all care to ensure that attachments are free from viruses or other defects. Transport for NSW assume no liability for any loss, damage or other consequences which may arise from opening or using an attachment.

 **Consider the environment. Please don't print this e-mail unless really necessary.**